

Semiconductor X-Ray Detectors

Tobias Eggert

Ketek GmbH

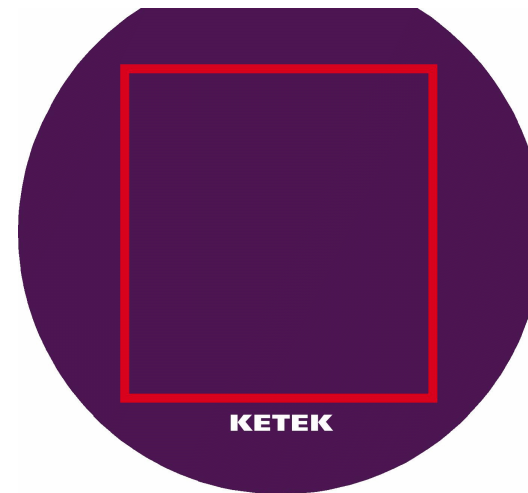

KETEK

Semiconductor X-Ray Detectors

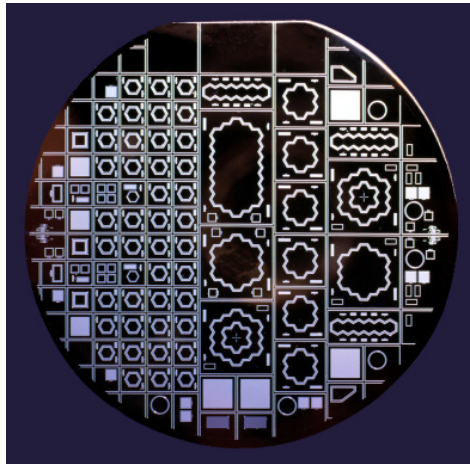

Part A Principles of Semiconductor Detectors

1. Basic Principles
2. Typical Applications
3. Planar Technology
4. Read-out Electronics

Part B Silicon Drift Detectors

1. Silicon Drift Detectors
2. GaAs Detectors
3. Outlook
4. Resume

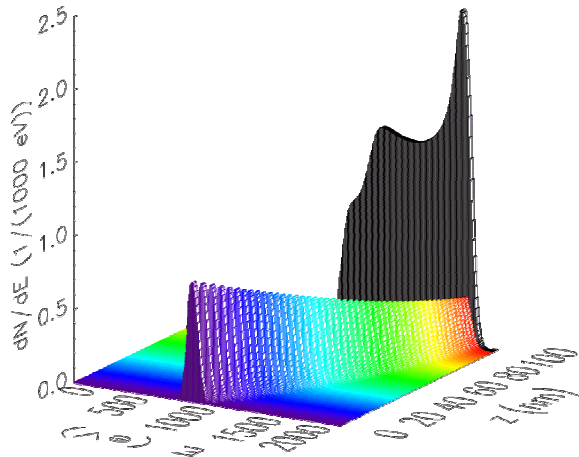

Motivation

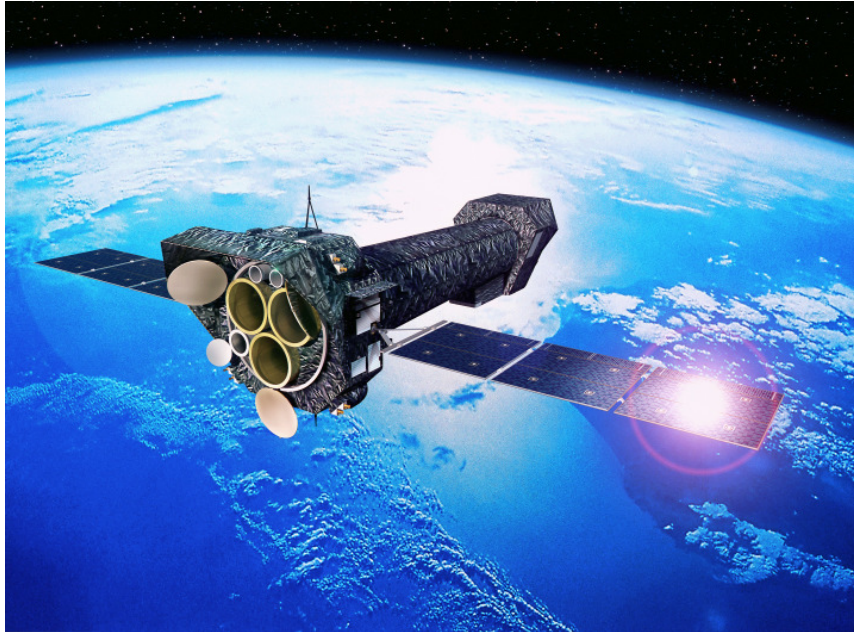

- Many discoveries and results of fundamental research are closely related to the quality of the instruments used
- Telescopes, Microscopes, Cameras
- New detector concepts enabled the discovery of many elementary particles (e^+ , ν , J/ψ)
- X-ray astronomy \rightarrow detectors with spatial and energy resolution
- Fully depleted pn-CCD

Why Semiconductor Detectors?

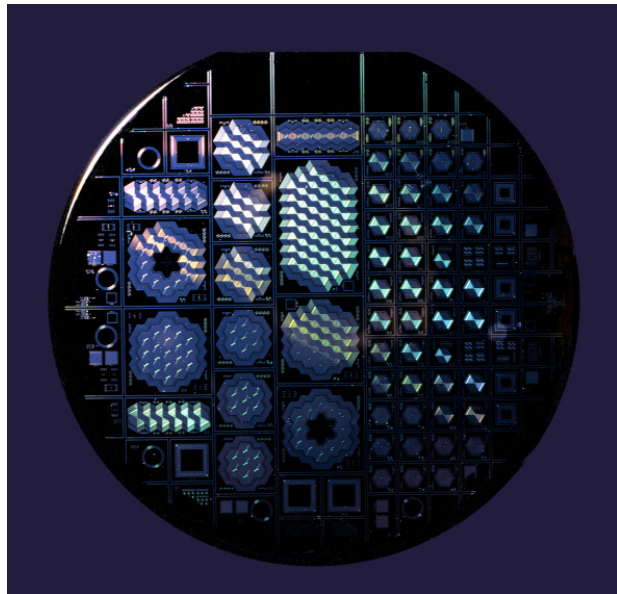

- Photons and charged particles ionize matter
- Gases: electron ion pairs are produced
- Semiconductors: electron hole pairs are produced
- Measurement of position and energy
- Pair creation energy in semiconductors is much lower than ionization energy in gases
- High density of solids \rightarrow high interaction probability
- Integration of transistors and read-out electronics

Semiconductor Detectors

p-i-n configuration → depletion zone

Al → saturation of free bonds
→ contacts p⁺
→ reflects visible light

p⁺ → maximum at the surface
→ no dead layer
→ high electric field strength

- e⁻-hole pairs generated by radiation
- charge separated and collected
- current mode: current prop. to flux and energy
- single photon counting: signal amplitude prop. to deposited charge

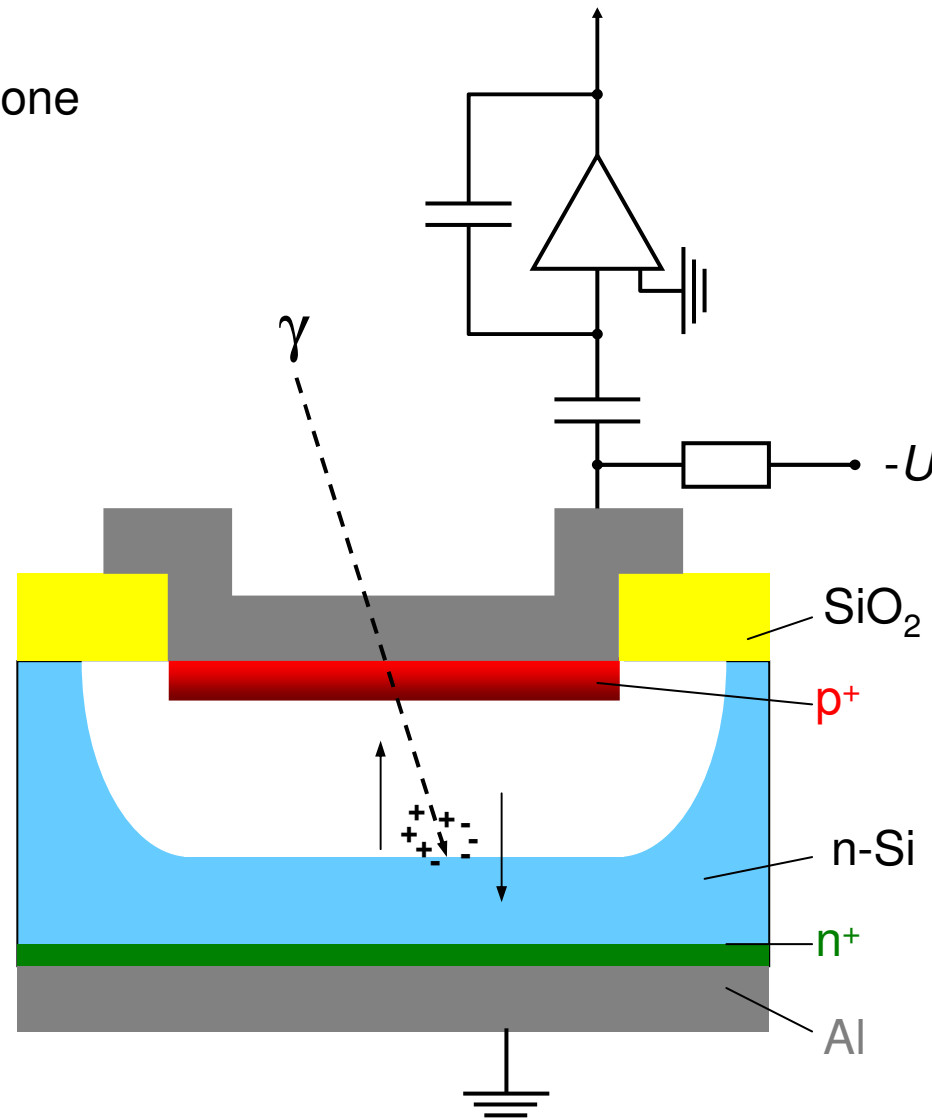

Semiconductor X-Ray Detectors

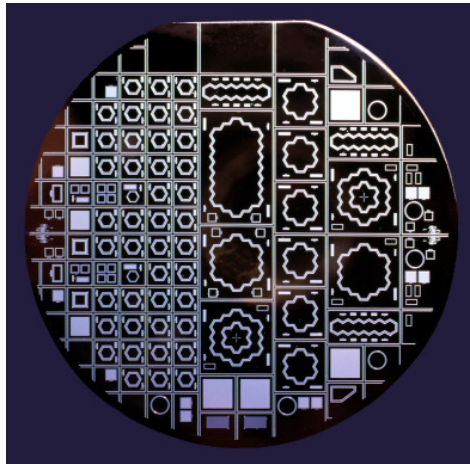

Part A Principles of Semiconductor Detectors

1. Basic Principles
2. Typical Applications
3. Planar Technology
4. Read-out Electronics

Part B Silicon Drift Detectors

1. Silicon Drift Detectors
2. GaAs
3. Outlook
4. Resume

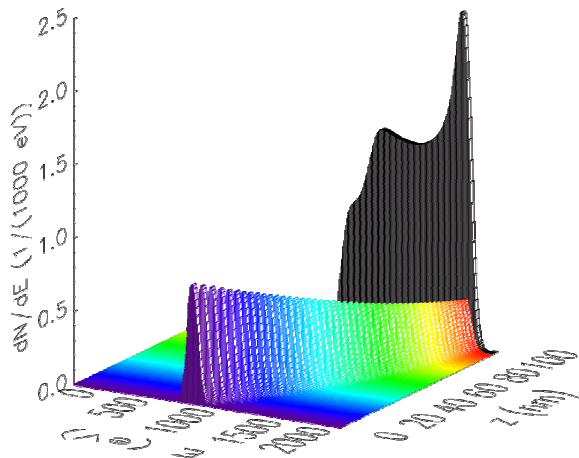

Applications in Basic Research

High Energy Physics

Silicon Strip detectors

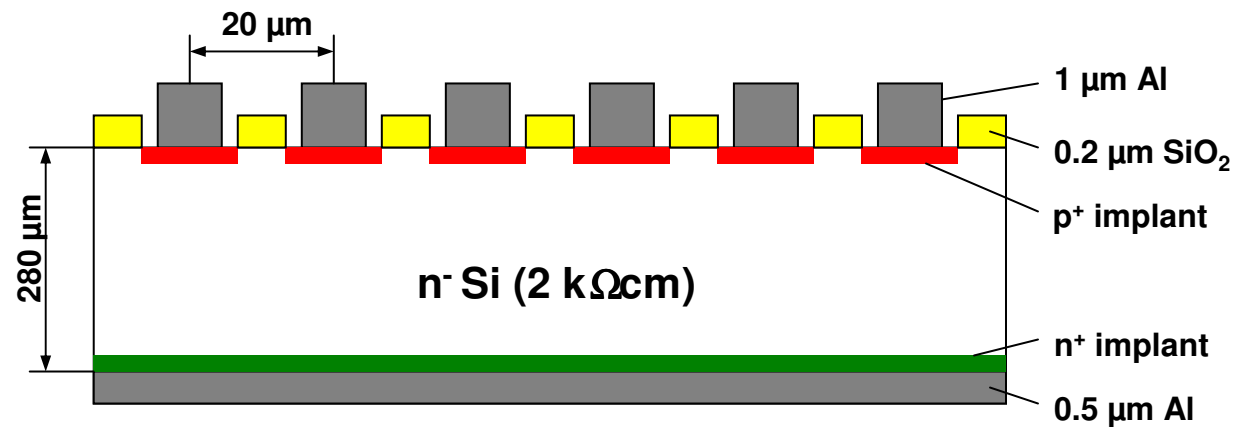

position resolution: $\text{pitch} / \sqrt{12}$

Diode array for position measurement

Applications in Basic Research

High Energy Physics

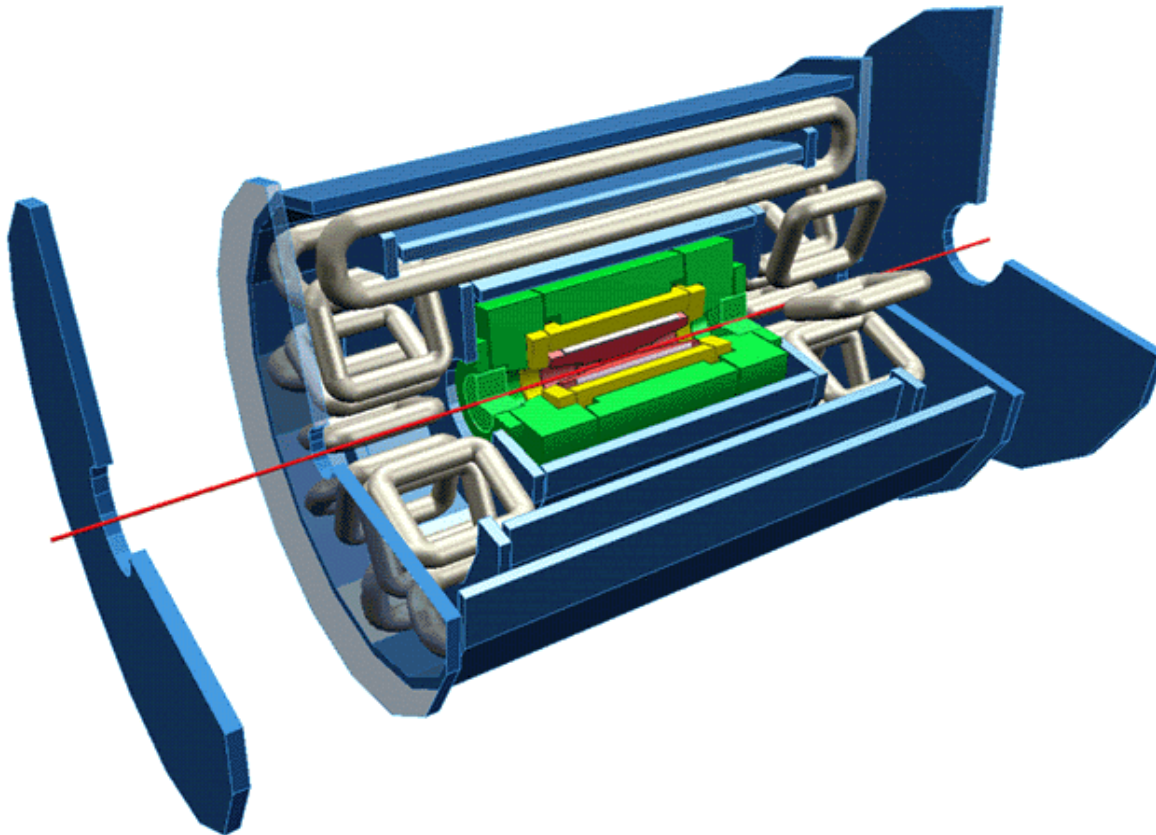

Strip or pixel detectors as inner trackers → position resolution

Applications in Basic Research

X-Ray Astronomy

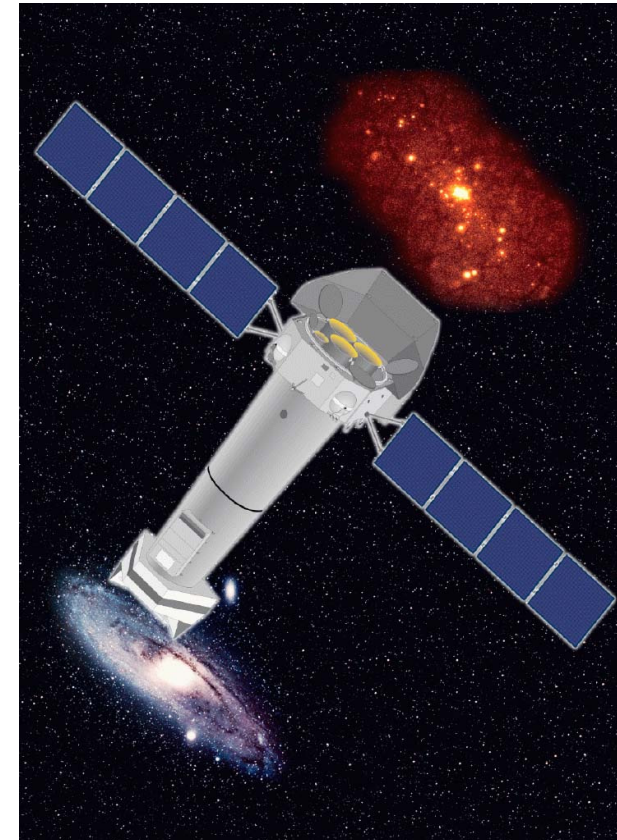
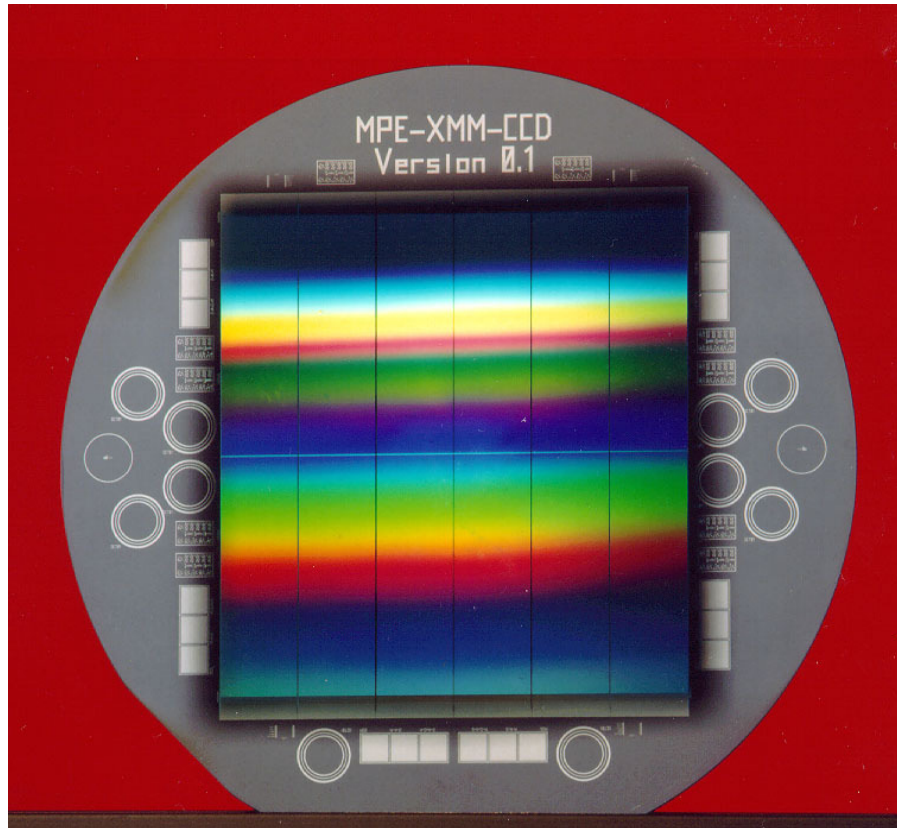

Spectroscopy of cosmic x-ray sources
Fully depleted pn-CCD on ESA's x-ray multi-mirror mission (XMM)

X-Ray Fluorescence

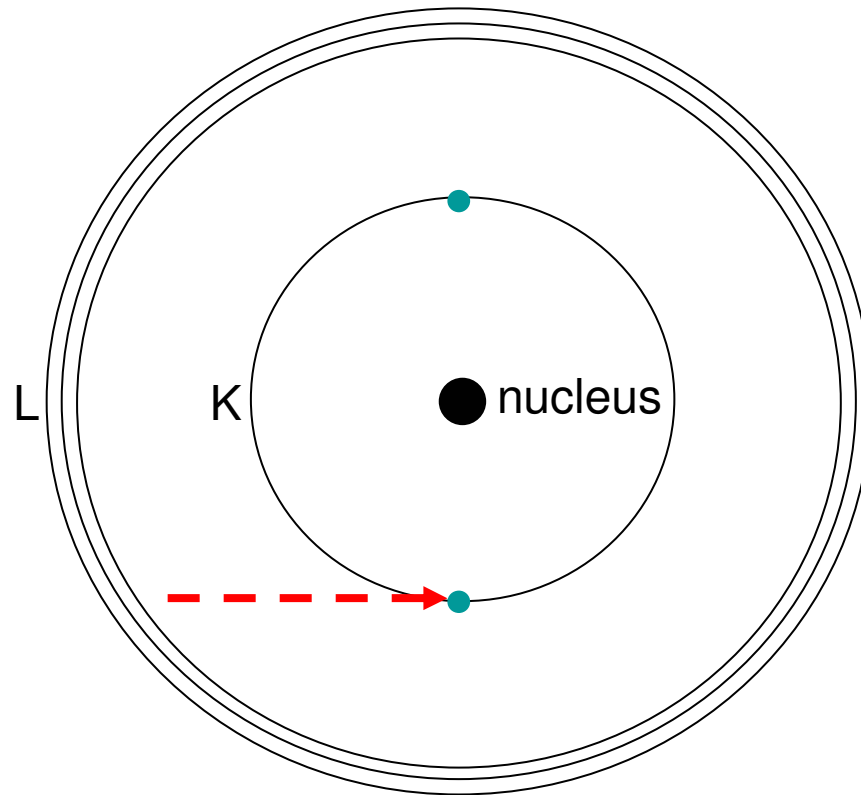

X-Ray Fluorescence

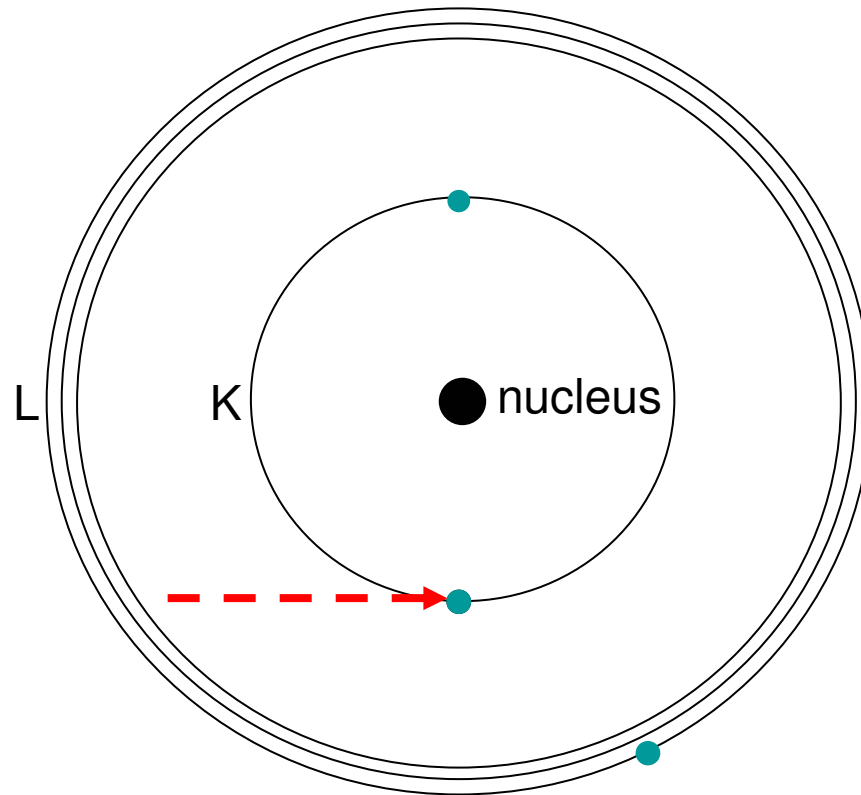

X-Ray Fluorescence

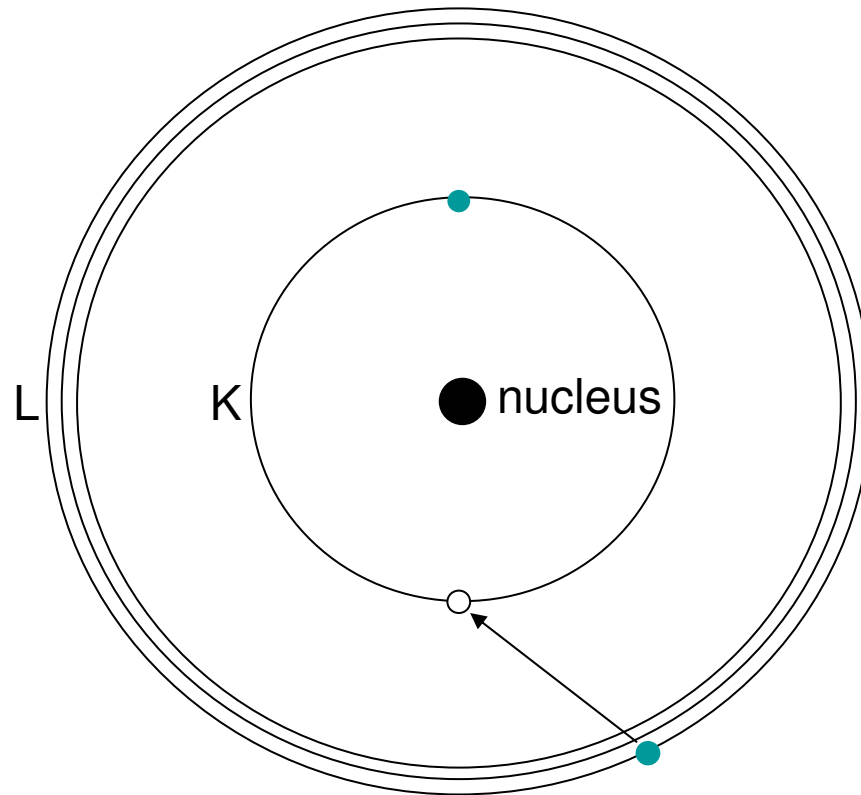

X-Ray Fluorescence

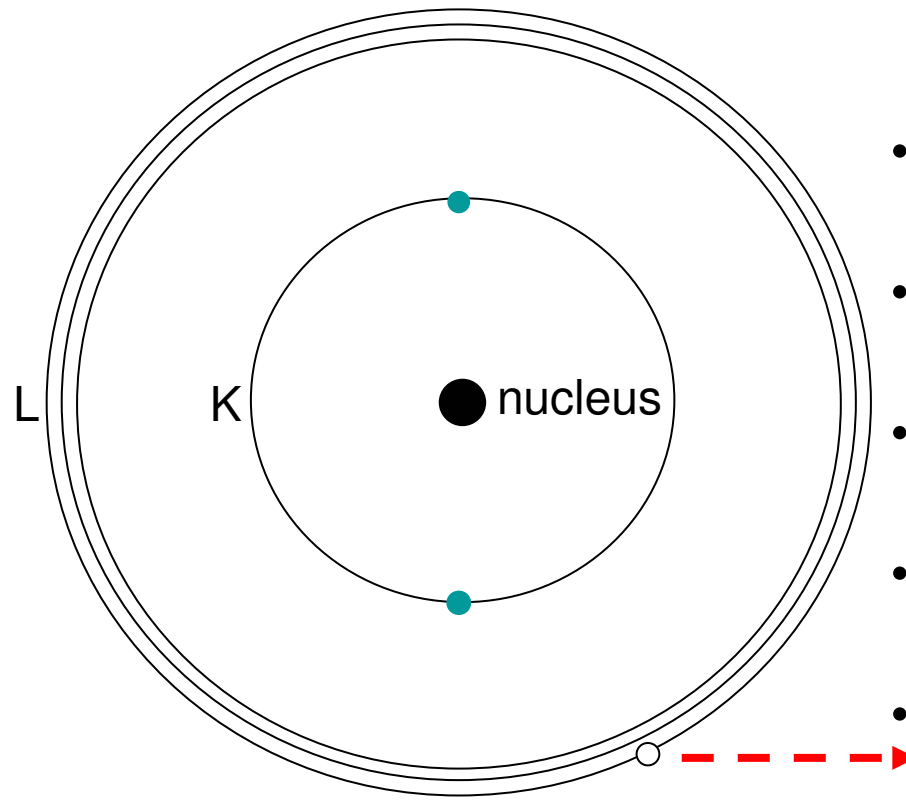

- Energy of fluorescence photon = difference of binding energies
- Moseley's Law:
 E_F prop. to Z^2
- Many transitions possible
- Transitions into K-shell:
 K_{α} K_{β} photons ("peaks")
- Transitions into L-shell:
 L_{α} L_{β} L_{γ} L_{η} photons
- Higher fluorescence yield for high Z elements

Application

X-Ray Fluorescence Analysis (XRF)

Excitation of
sample with
X-rays

XRF-Analyse (X-Ray Fluorescence)

Untersuchung eines Leichentuchs
(Antinopolis, III. Jahrhundert n. Chr., Vatikanische Museen)

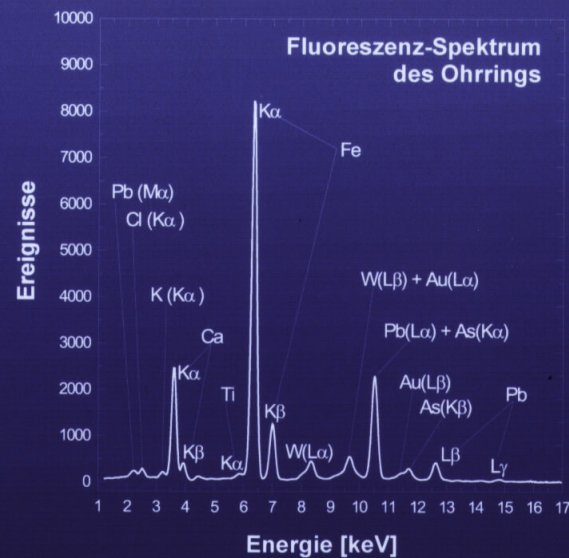
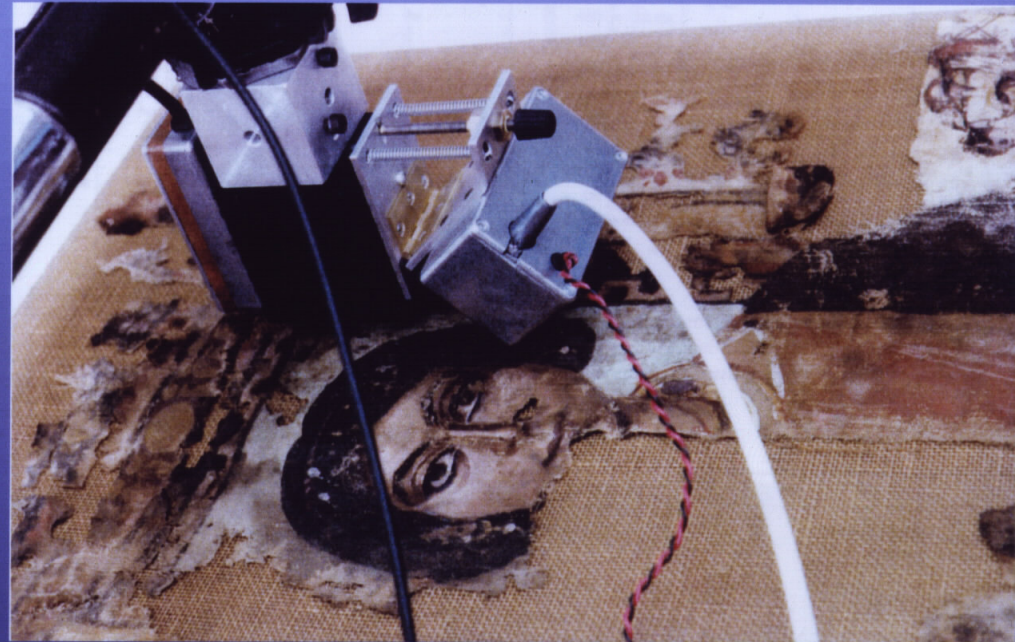

Photographie des Detektor-Moduls

Application

XRF with scanning electron microscopes

Excitation of sample with electrons

Elektronenstrahl-Mikroanalyse mit Silizium-Driftdetektoren

Untersuchung einer Meteoritenprobe

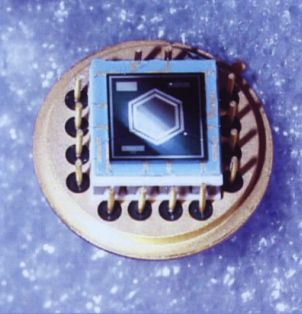

Silizium-Driftdetektor 5 mm²

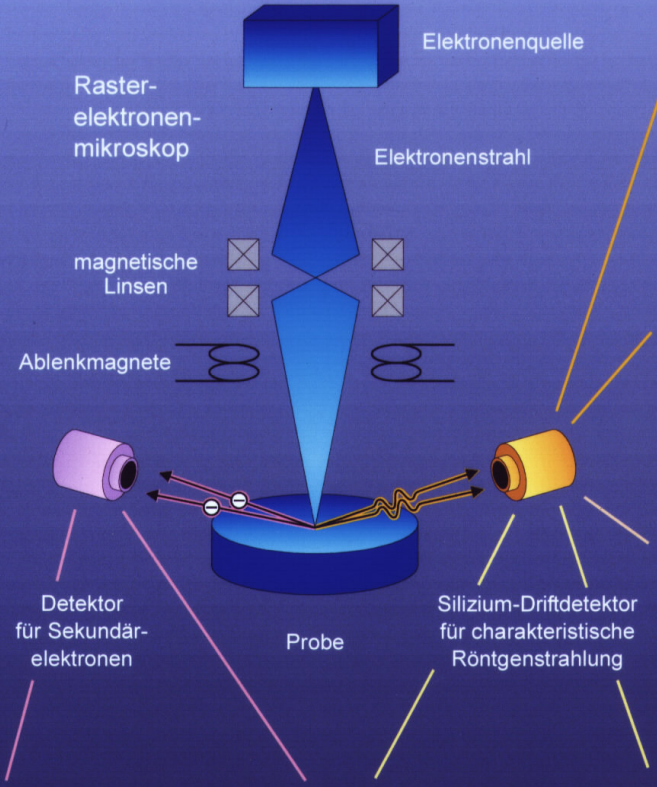

Elektronenquelle

Raster-elektronen-mikroskop

Elektronenstrahl

magnetische Linsen

Ablenkmagnete

Detektor für Sekundär-elektronen

Probe

Silizium-Driftdetektor für charakteristische Röntgenstrahlung

Fe

Mo

Ni

SE

Mg

Ca

Oberflächenbild

Element Imaging

Silizium-Driftdetektor 5 mm²

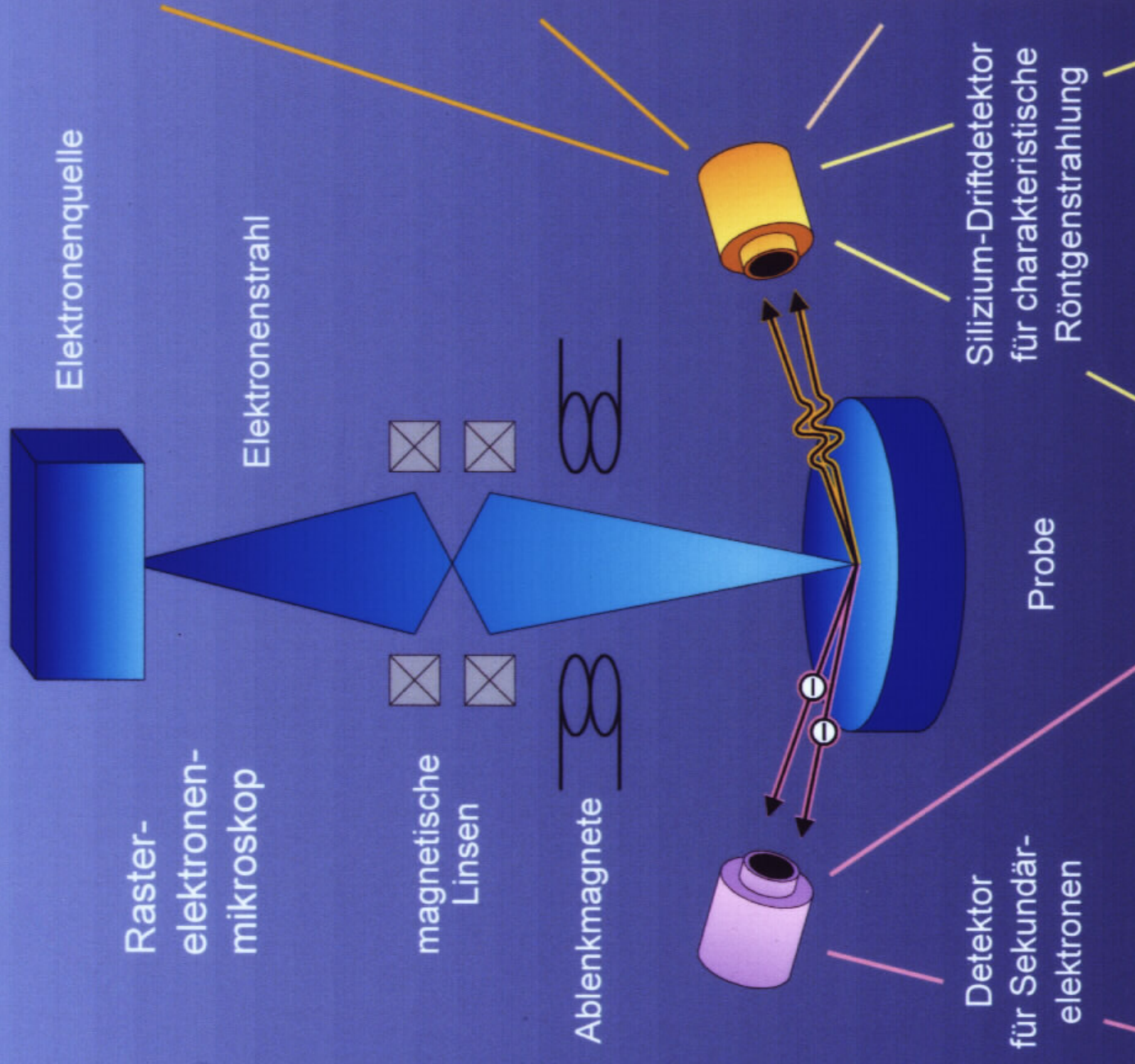
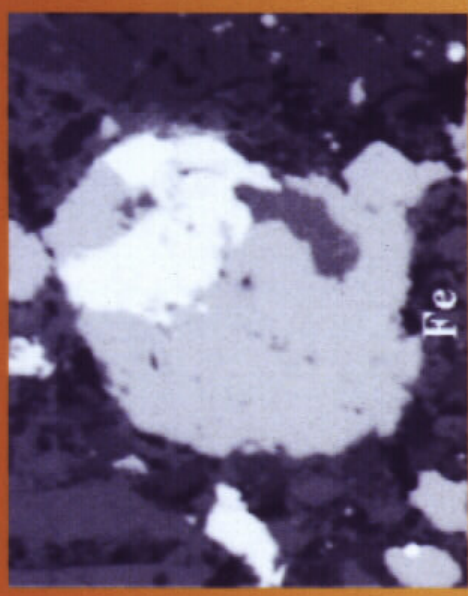

NASA Mars Rovers

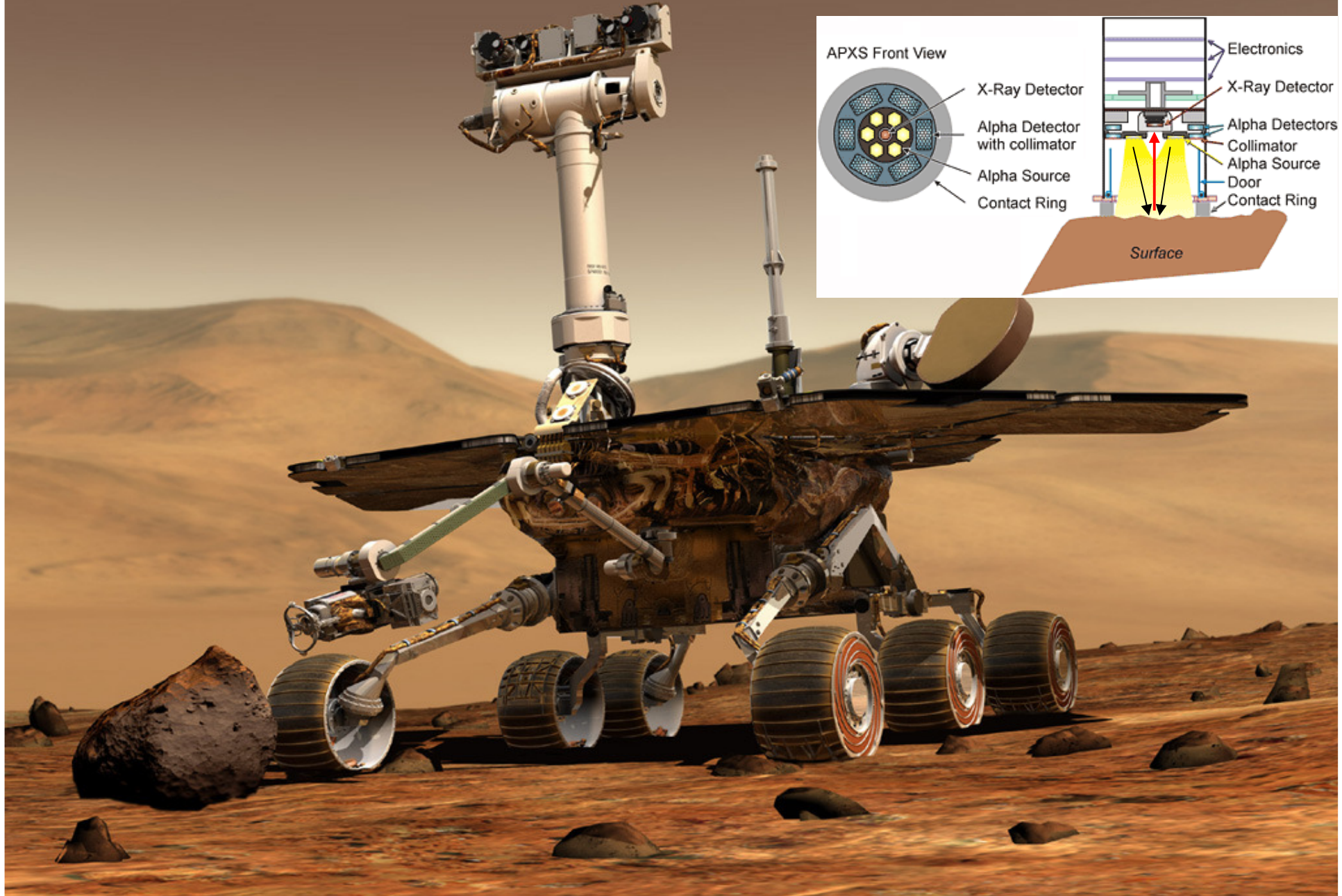

Semiconductor X-Ray Detectors

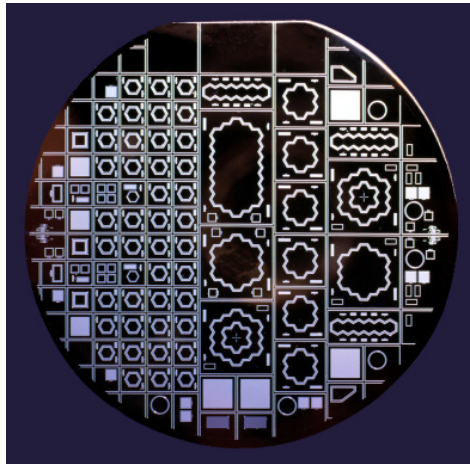

Part A Principles of Semiconductor Detectors

1. Basic Principles
2. Typical Applications
3. Planar Technology
4. Read-out Electronics

Part B Silicon Drift Detectors

1. Silicon Drift Detectors
2. GaAs Detectors
3. Outlook
4. Resume

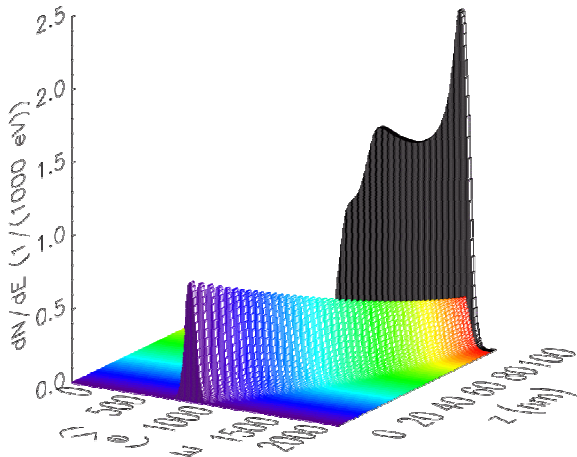

Planar Technology

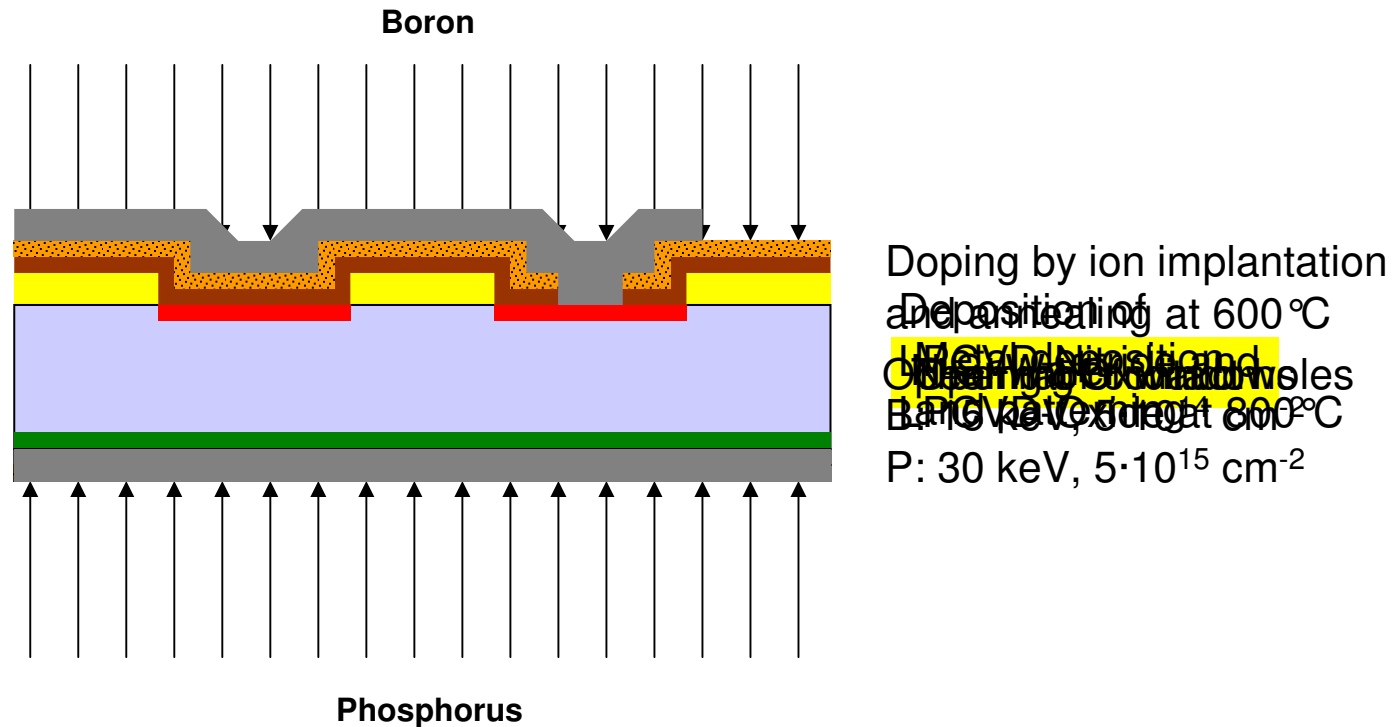

Differences to conventional planar technology

- Wafer structured on both sides
- Larger structures
- Low temperature processes
- Less diffusion of impurities
- Low leakage currents and high charge carrier life-times

Planar Technology

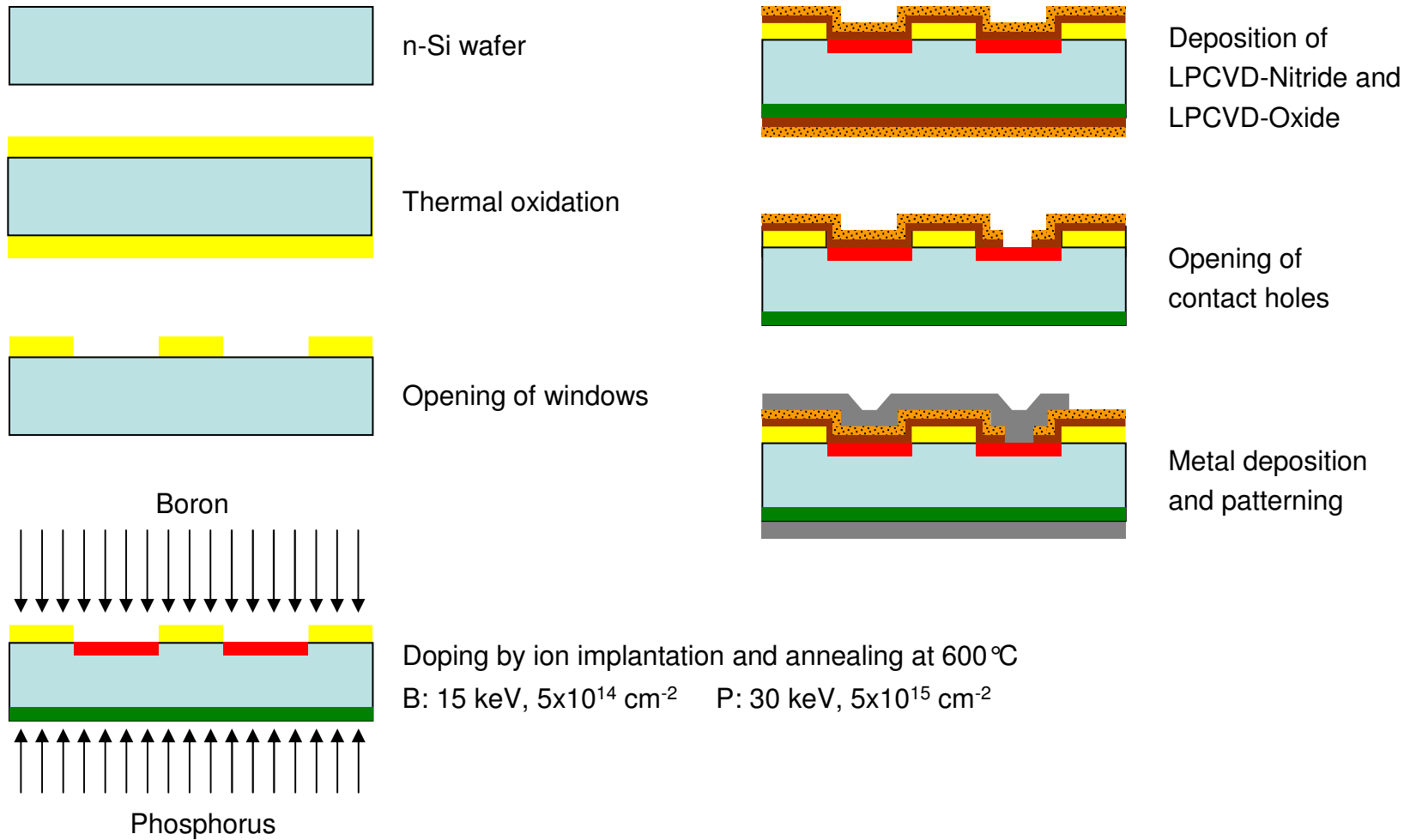

Important Semiconductor Properties

		Si	Ge	GaAs	SiC
atomic number		14	32	31 / 33	14 / 12
atomic weight		28.09	72.59	144.63	40
density	g/cm ³	2.33	5.33	5.32	3.21
band gap (RT)	eV	1.12	0.66	1.42	3.0
av. energy for e-h pair	eV	3.65	2.85	4.2	~ 8.5
electron mobility μ_e	cm ² /Vs	1500	3900	8500	~ 1000
hole mobility μ_h	cm ² /Vs	450	1900	400	~ 100
minority carrier lifetime τ	s	$2.5 \cdot 10^{-3}$	10^{-3}	$\sim 10^{-8}$	$\sim 10^{-6}$
$\mu\tau$ – product (e)	cm ² /V	2 – 5	5	$\sim 10^{-4}$	$\sim 10^{-3}$
$\mu\tau$ – product (h)	cm ² /V	1 – 2	2	$\sim 10^{-5}$	$\sim 10^{-4}$
intrinsic resistivity	Ω cm	$2.3 \cdot 10^5$	47	10^8	$> 10^{12}$
intrinsic carrier conc.	cm ⁻³	$1.45 \cdot 10^{10}$	$2.5 \cdot 10^{13}$	$1.8 \cdot 10^6$	10^{-6}

pn-Junction for Detector Applications

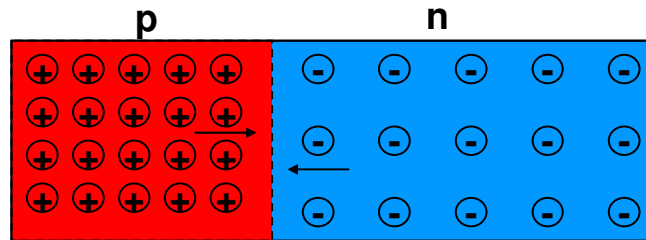

diffusion of majority carriers

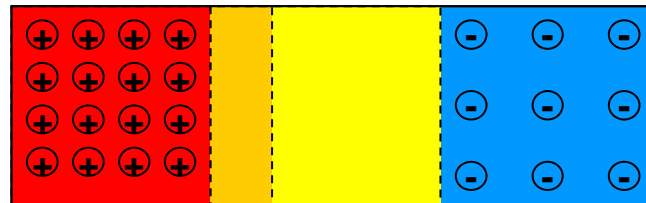

formation of depletion layers

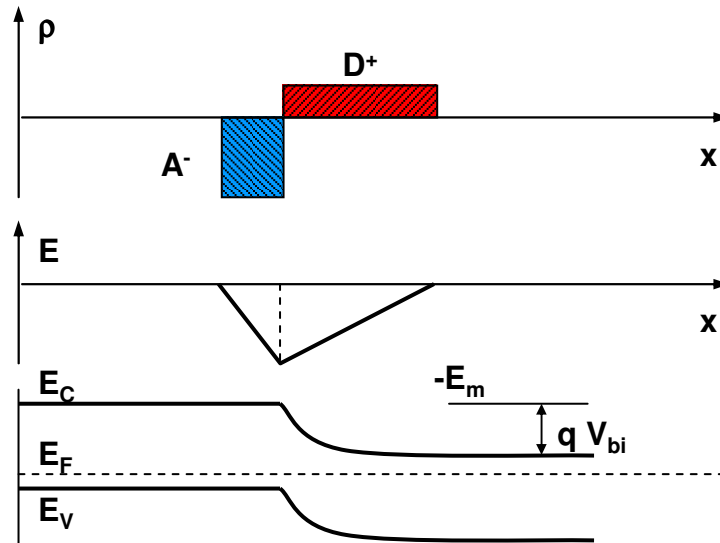

fixed space charge of acceptors (A^-) and donors (D^+)

electric field due to space charge

band bending of the junction
built in voltage

Properties of Si pn-Junction Detectors

Depletion layer thickness d

$$d/\text{cm} = 5 \cdot 10^{-3} (\rho U / (\Omega\text{cmV}))^{1/2}$$

ρ resistivity
 U bias voltage

Capacitance C

$$C/\text{pF} = 2 \cdot 10^4 A/\text{cm}^2 (\rho U / (\Omega\text{cmV}))^{-1/2} A$$

A junction area

Reverse current I_R

$$I_R = I_D + I_S + I_G$$

I_D diffusion current
 I_S surface leakage c.
 I_G generation current

For thick depletion layers

$$I_R = I_G = q (n_i/\tau) A 5 \cdot 10^{-3} (\rho U)^{1/2}$$

$$I_R \sim U^{1/2}/\tau$$

n_i $1.5 \cdot 10^{10} \text{ cm}^{-3}$
 intrinsic carrier conc.
 τ minority carrier lifetime
 q $1.6 \cdot 10^{-19} \text{ As}$

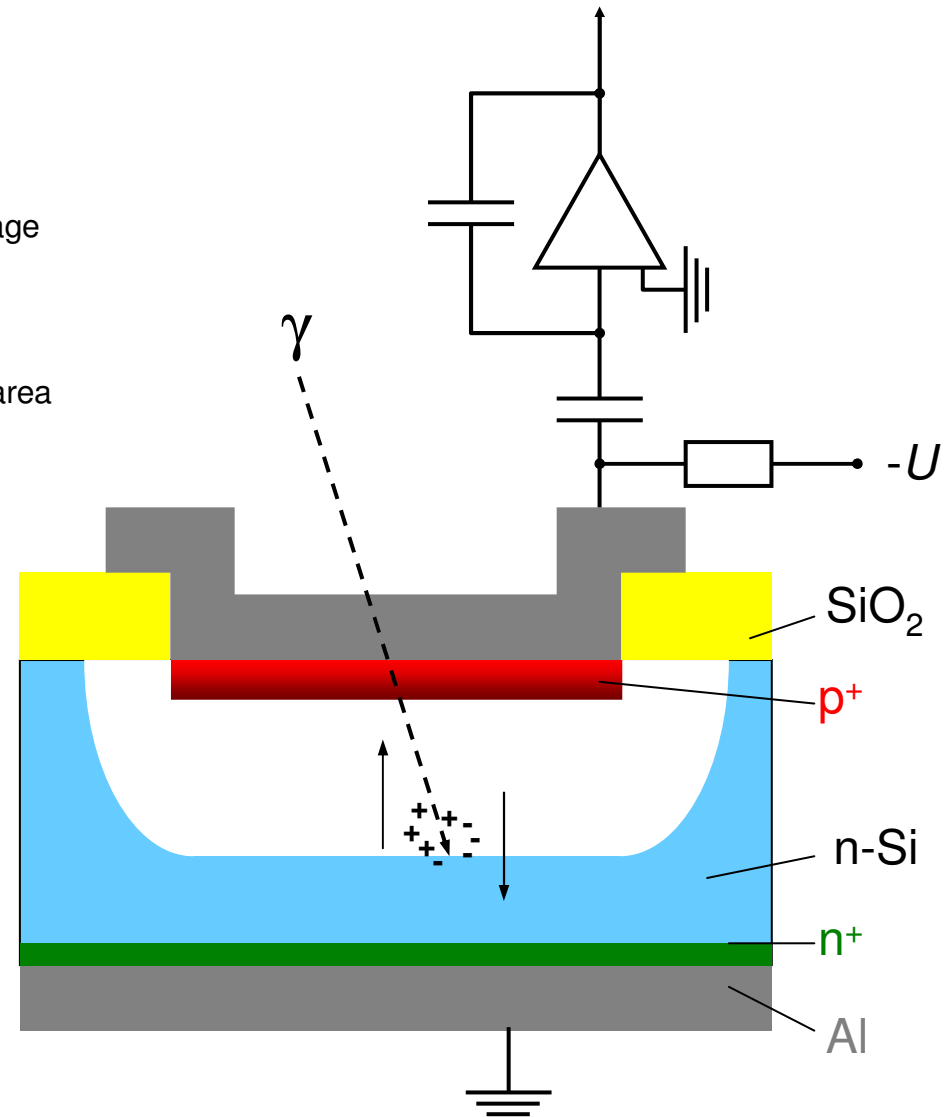

The Response of Energy Dispersive X-Ray Detectors

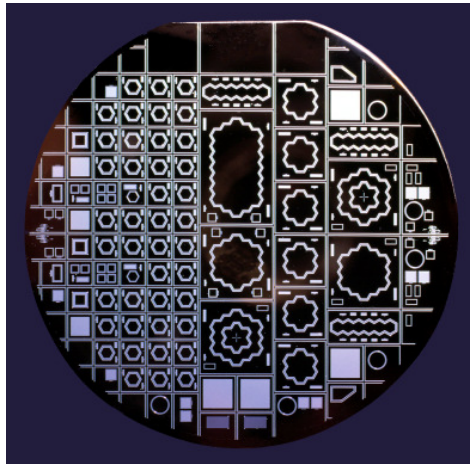

Part A Principles of Semiconductor Detectors

1. Basic Principles
2. Typical Applications
3. Planar Technology
4. Read-out Electronics, Spectra, Efficiency Limits

Part B Silicon Drift Detectors

1. SDD structure
2. Low Energy Measurements/Experimental Setup
3. Calculation of Spectral Contributions
4. Results
5. Resume

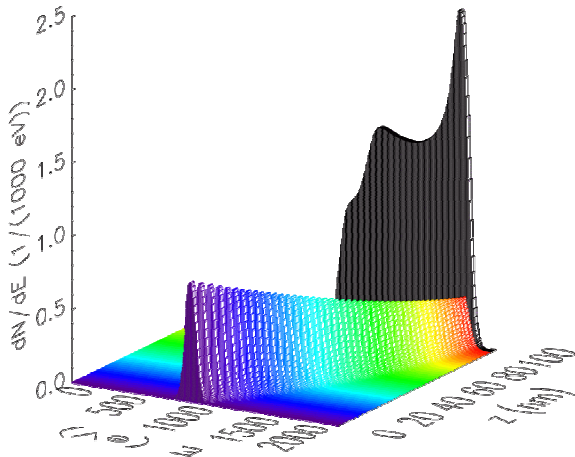

Read Out Electronics

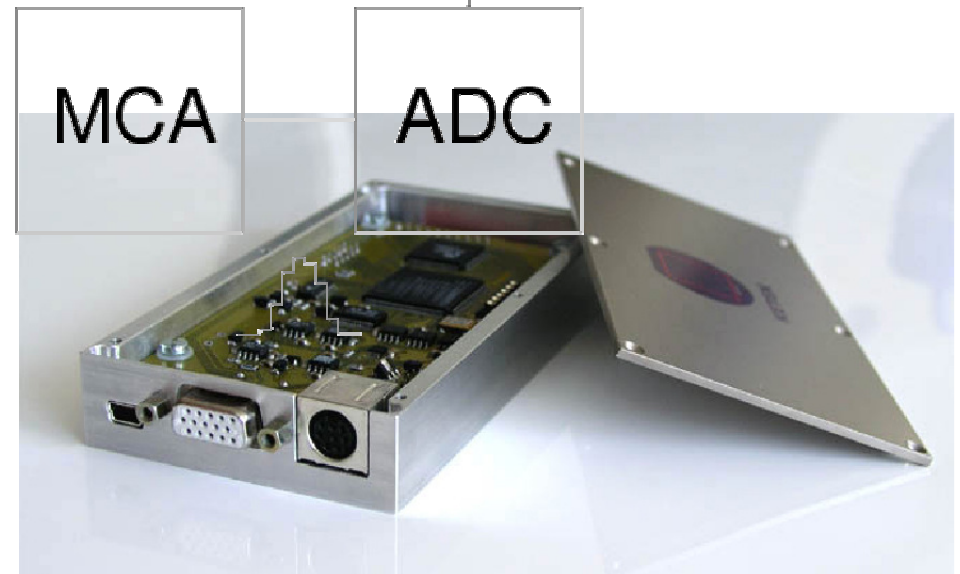
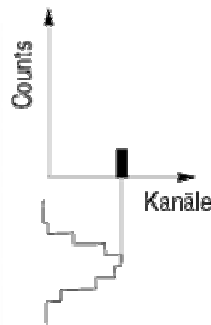
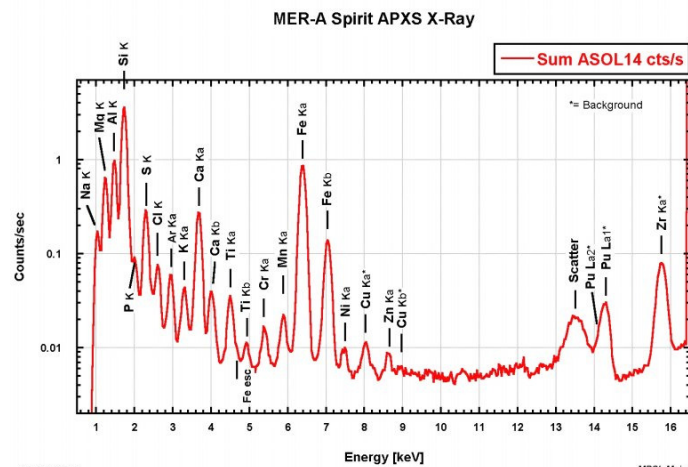
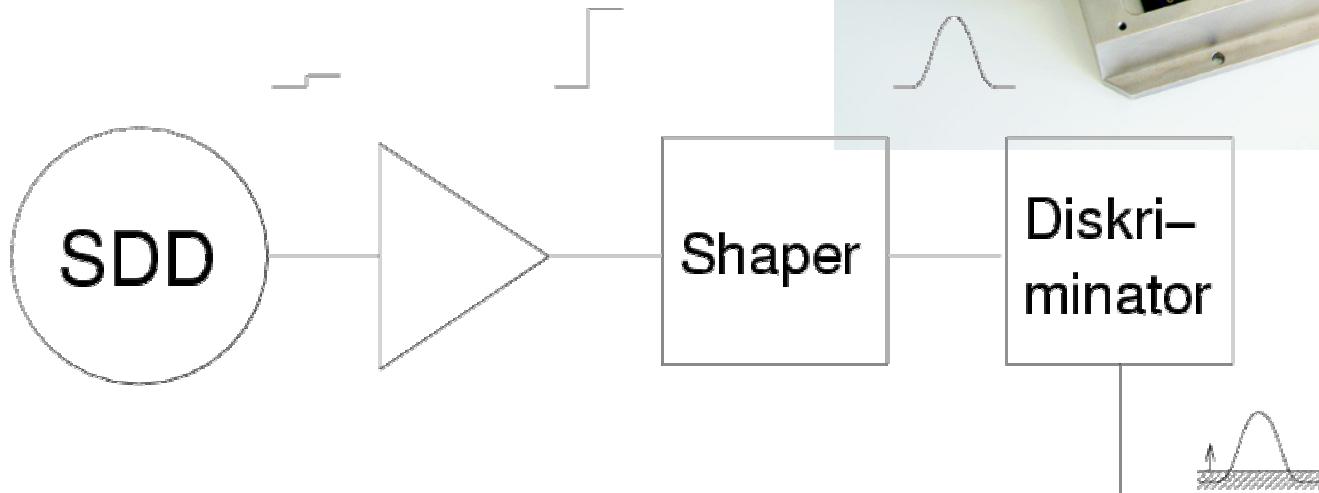
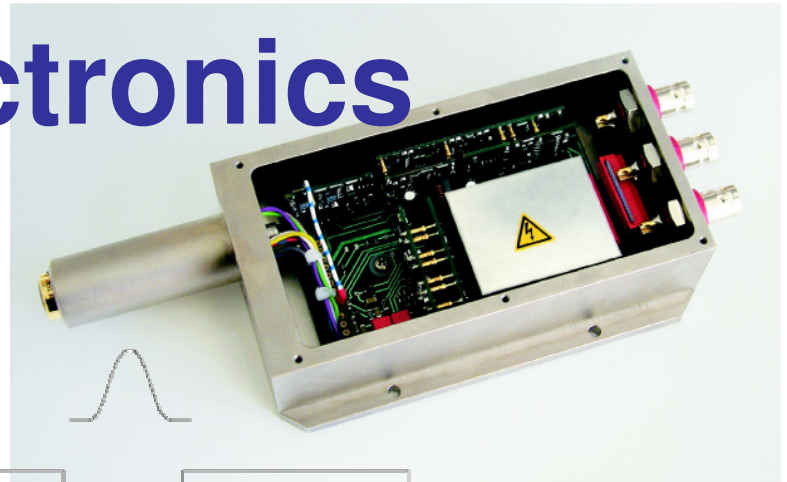
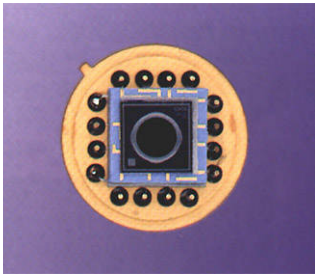

Requirements on Spectrometers

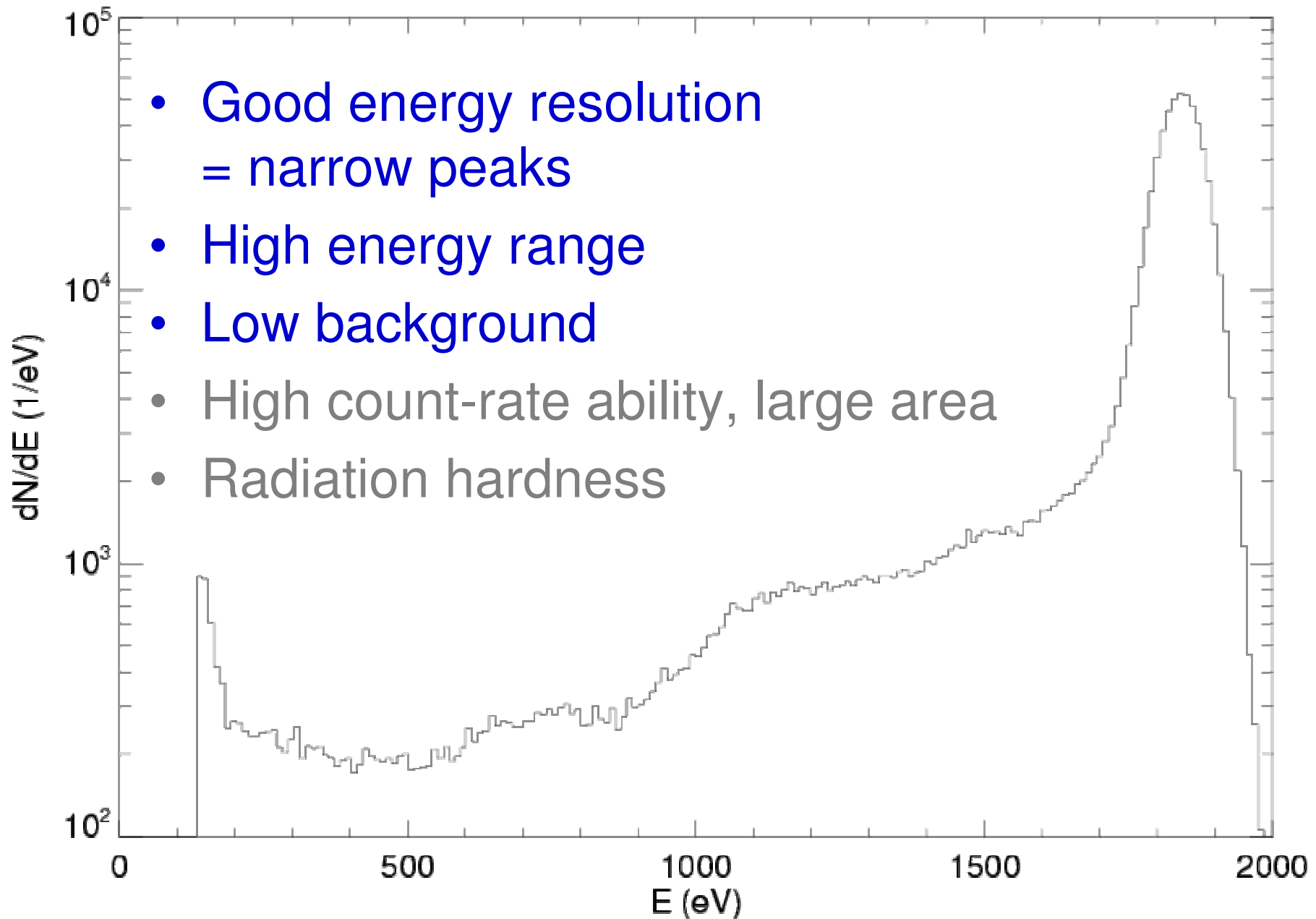

Spectrum of Martian Soil

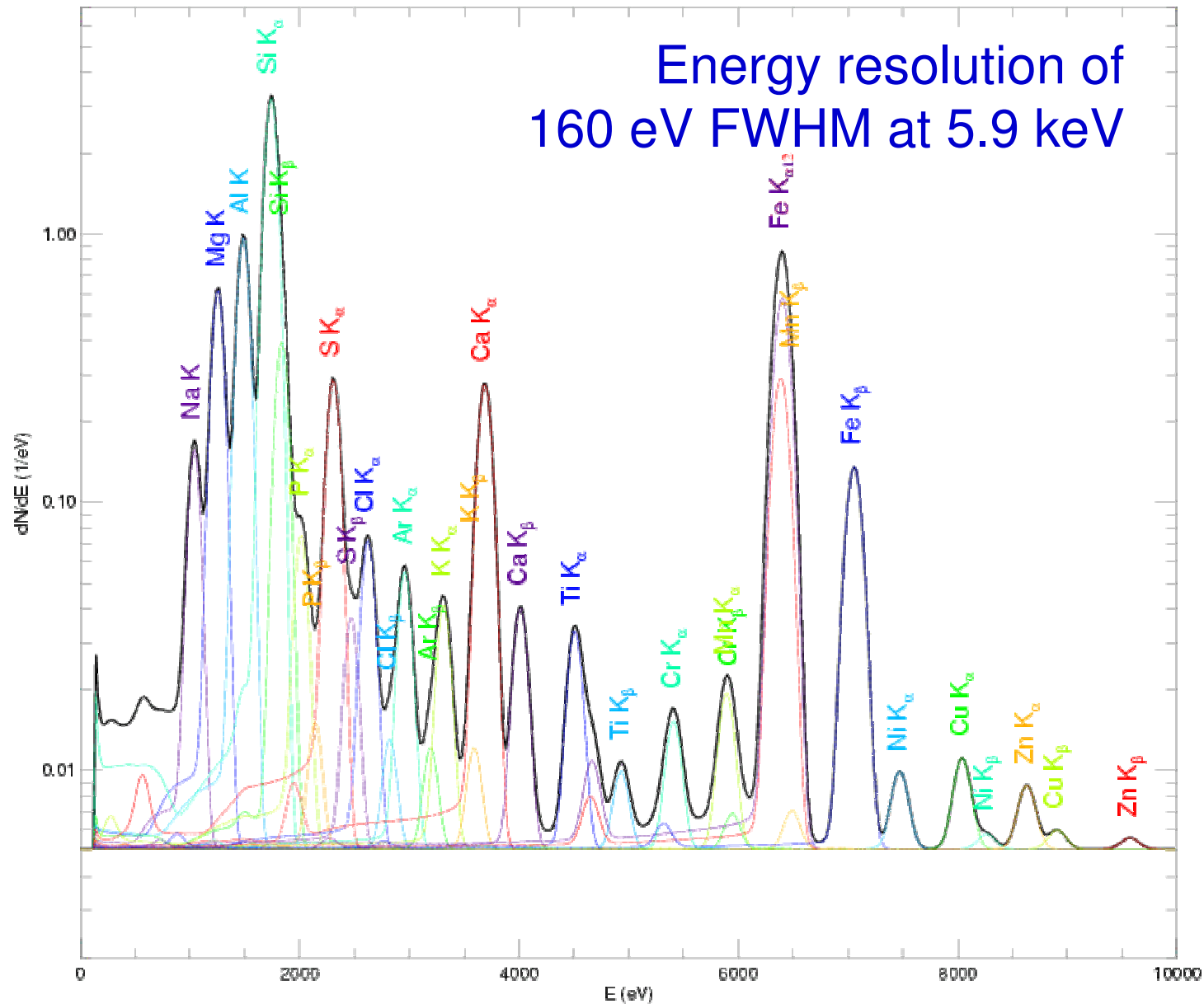

Spectrum of Martian Soil

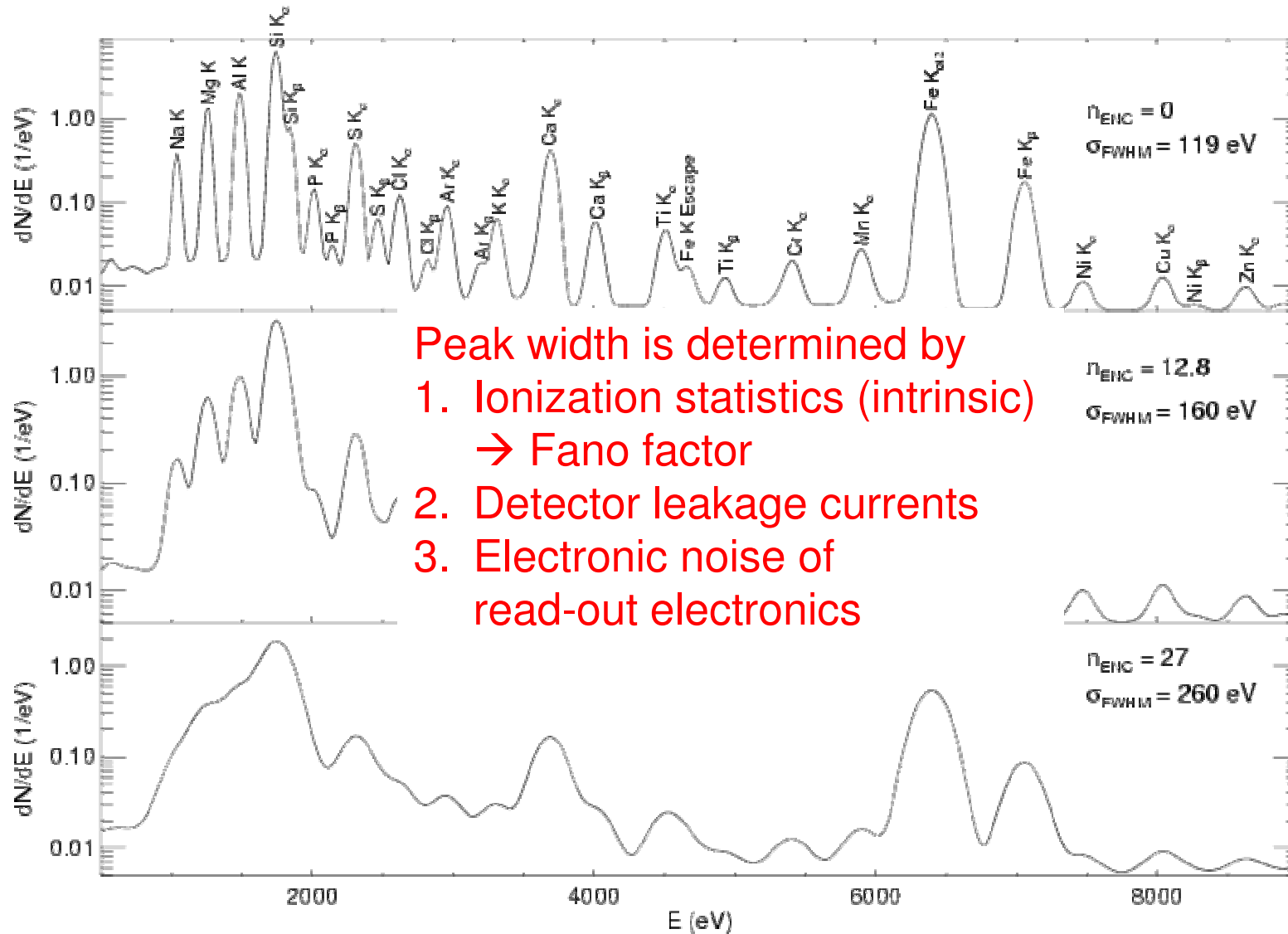

Absorption Lengths of Si + Al

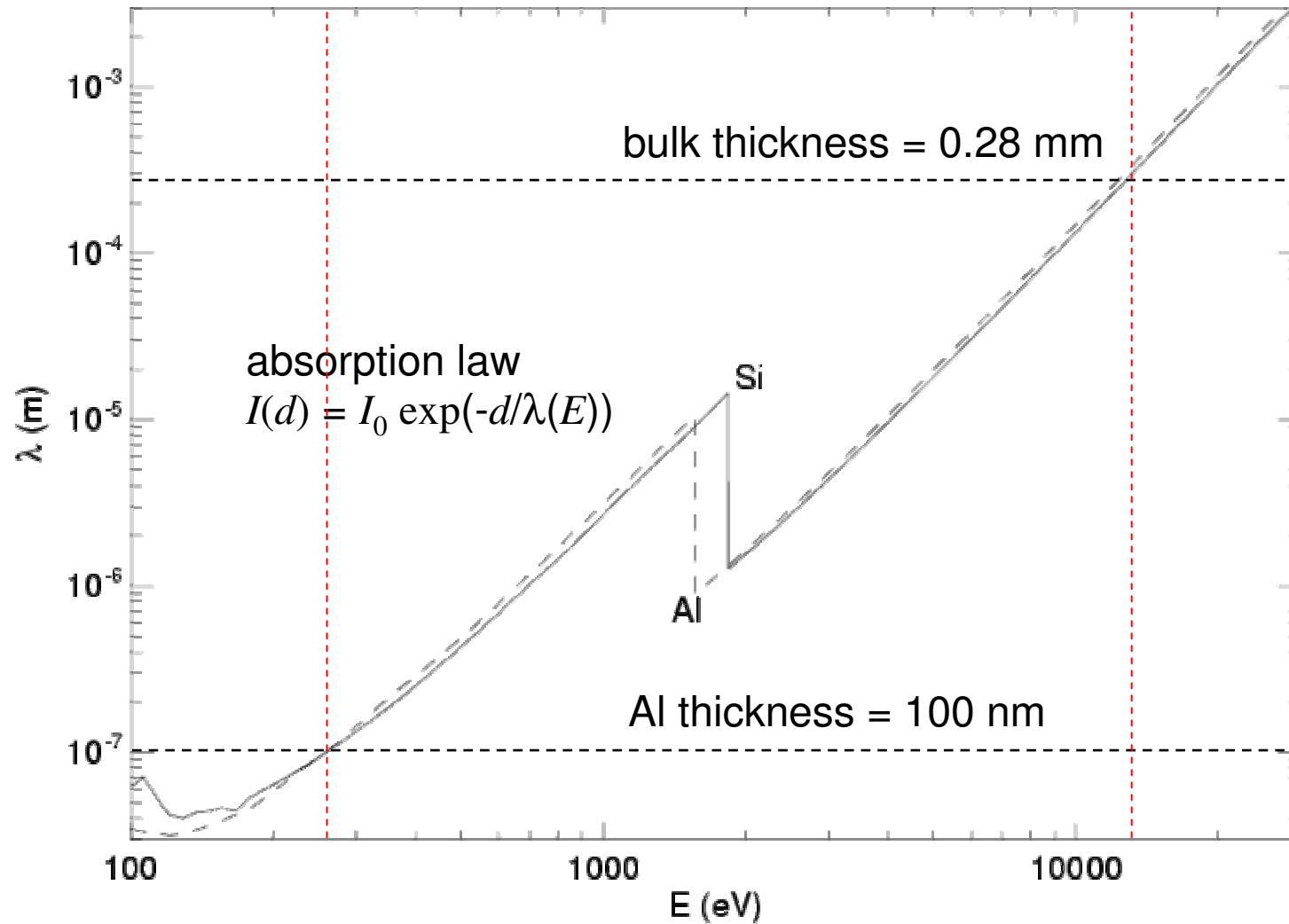

Good efficiency from 250 eV to 11 keV
(20 keV)

Quantum Efficiency

ε = interaction probability

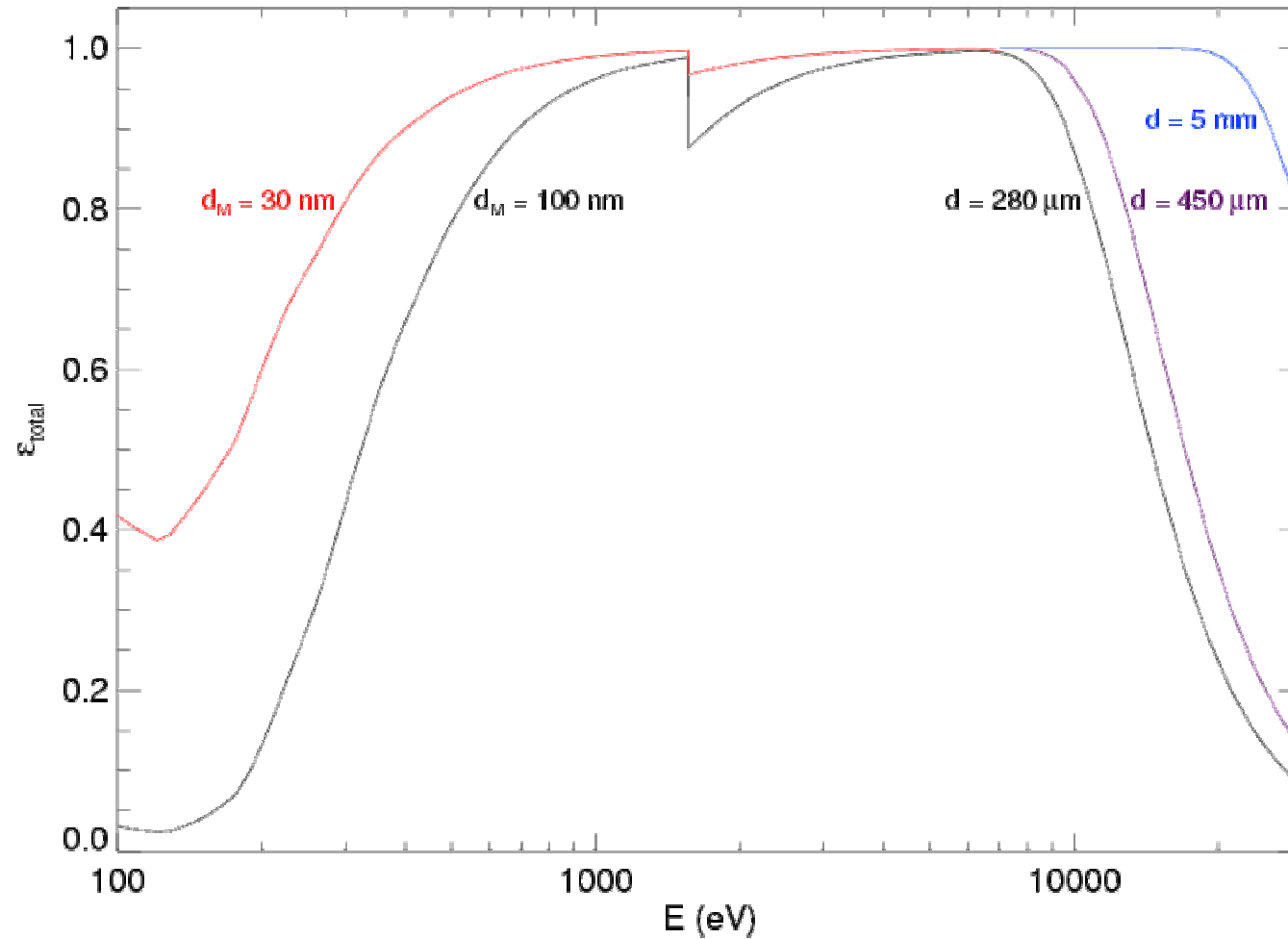

Soft X-Rays from 100 eV – 30 keV

Conventional Radiation Detectors

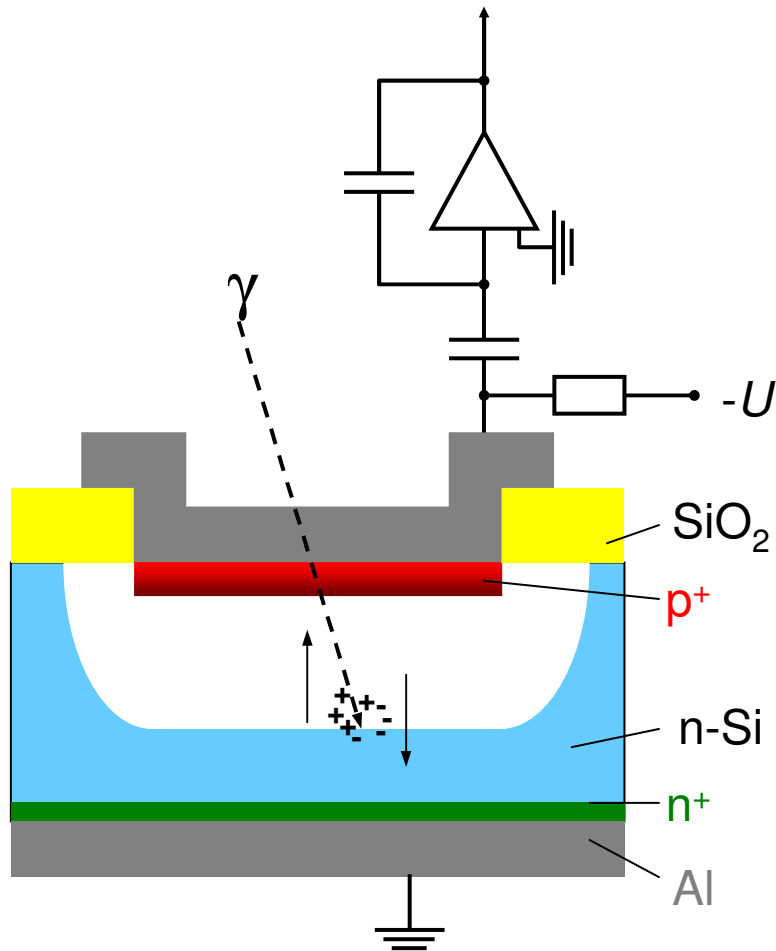

- Main problem of pin diodes and conventional Si(Li)s:
- Capacitance prop. to area
- Large active area required for high sensitivity
- Low capacitance required for low noise
- The drift principles allows both, large area and low capacitance

The Response of Energy Dispersive X-Ray Detectors

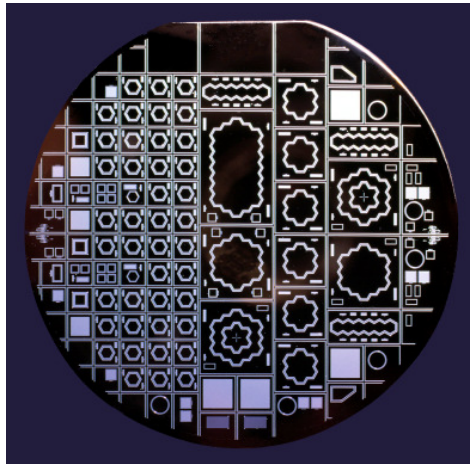

Part A Principles of Semiconductor Detectors

1. Basic Principles
2. Typical Applications
3. Planar Technology
4. Read-out Electronics, Spectra, Efficiency Limits

Part B Silicon Drift Detectors

1. Silicon Drift Detectors
2. GaAs Detectors
3. Outlook
4. Resume

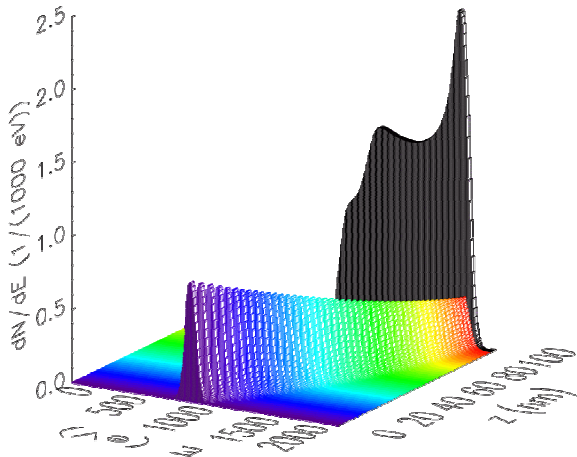

Silicon Drift Detector (SDD)

- High resistivity, high purity n-type silicon ($10^{12}/\text{cm}^3$)
- pn junctions on both sides
- Drift rings at the front side, integrated voltage dividers
- Homogeneous entrance window at the back side

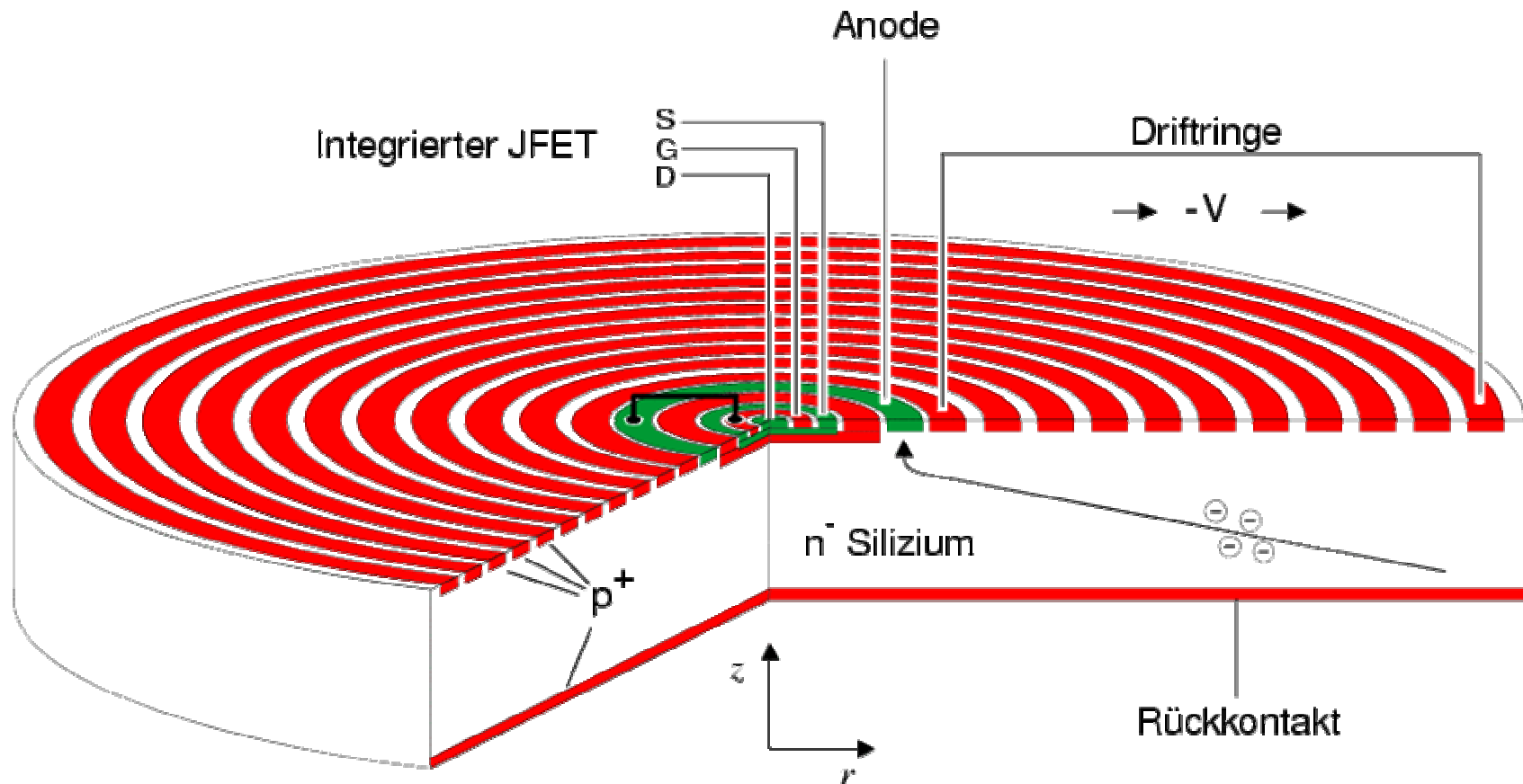

Silicon Drift Detector (SDD)

- Depletion from back contact towards bulk contact (n^+ , not shown)
- Vertical and lateral drift field \rightarrow small anode size \rightarrow low capacitance
- Low leakage currents, low noise, high energy resolution
- Thermoelectrically cooled to $-20\text{ }^\circ\text{C}$ (other detectors need 77 K)
- Current entrance window: large background for energies $< 300\text{ eV}$

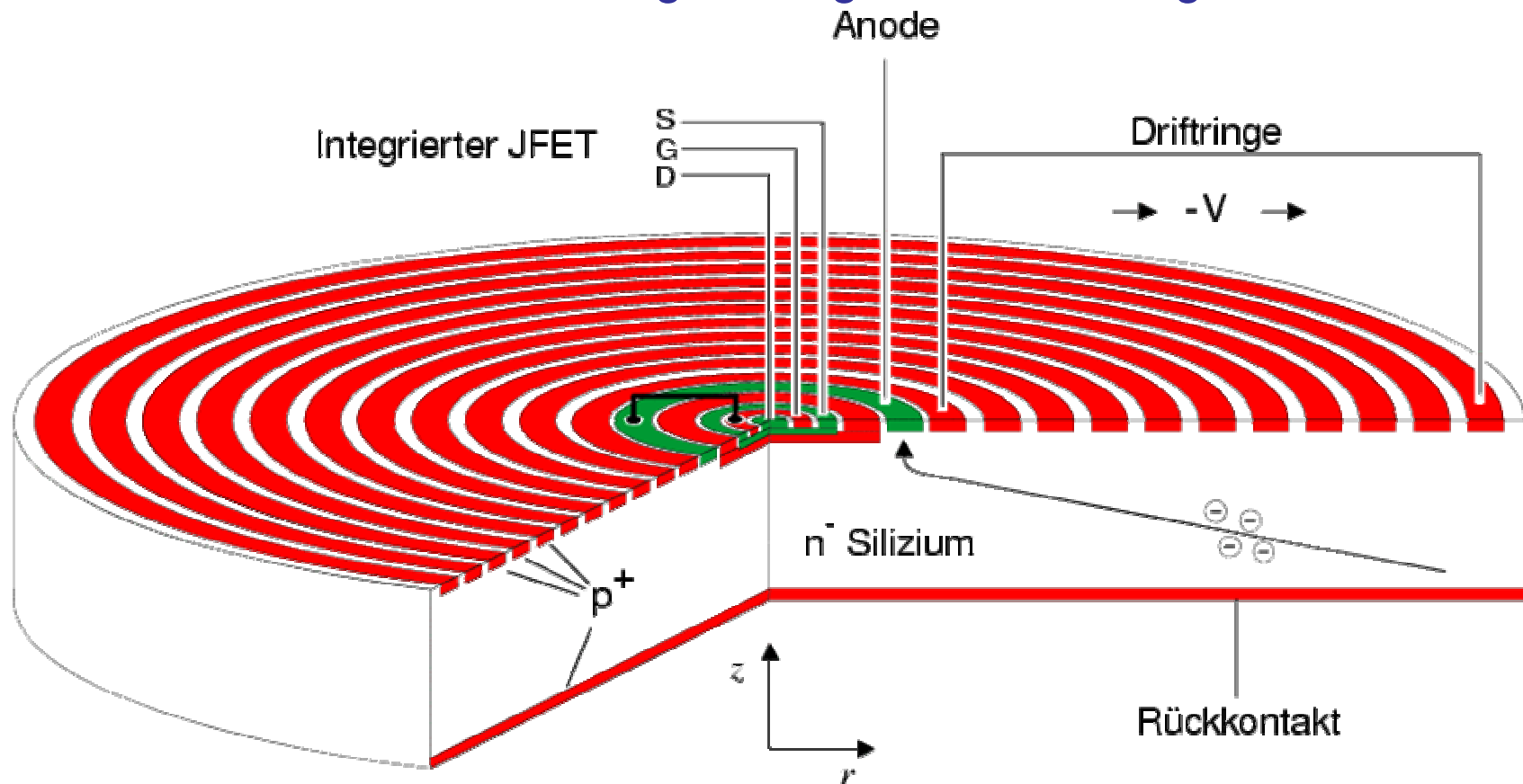

Silicon Drift Detector (SDD)

- Integrated Junction Field Effect Transistor
- Energy resolution down to 135 eV (FWHM) at 5.9 keV
- No pickup noise, no microphony, low overall noise
- Shaping times 250 ns ... 1 μ s (other detectors: 20 μ s)
- Count-rate ability up to 10^6 /s, suited for high X-ray intensities

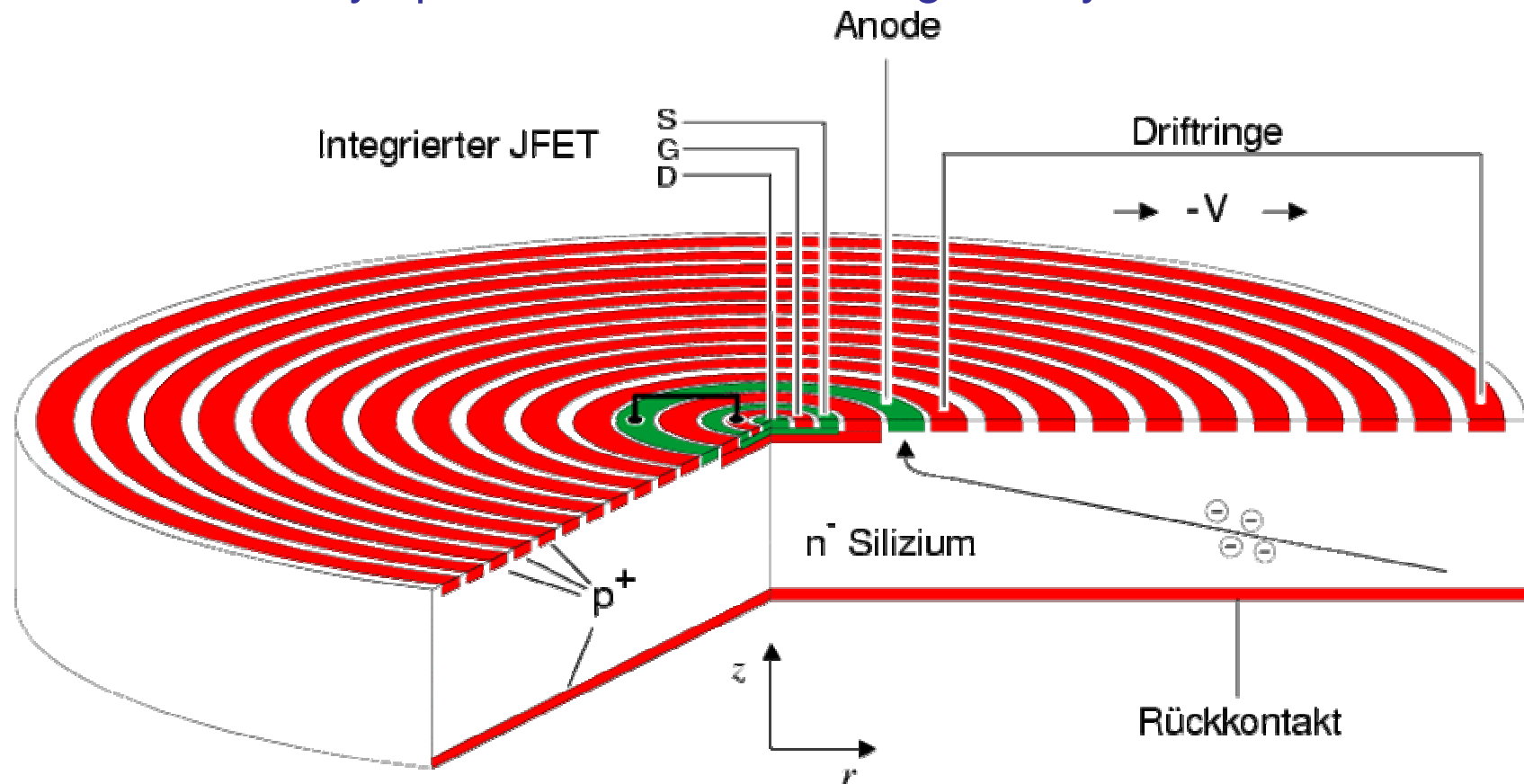

Drift Field Configuration

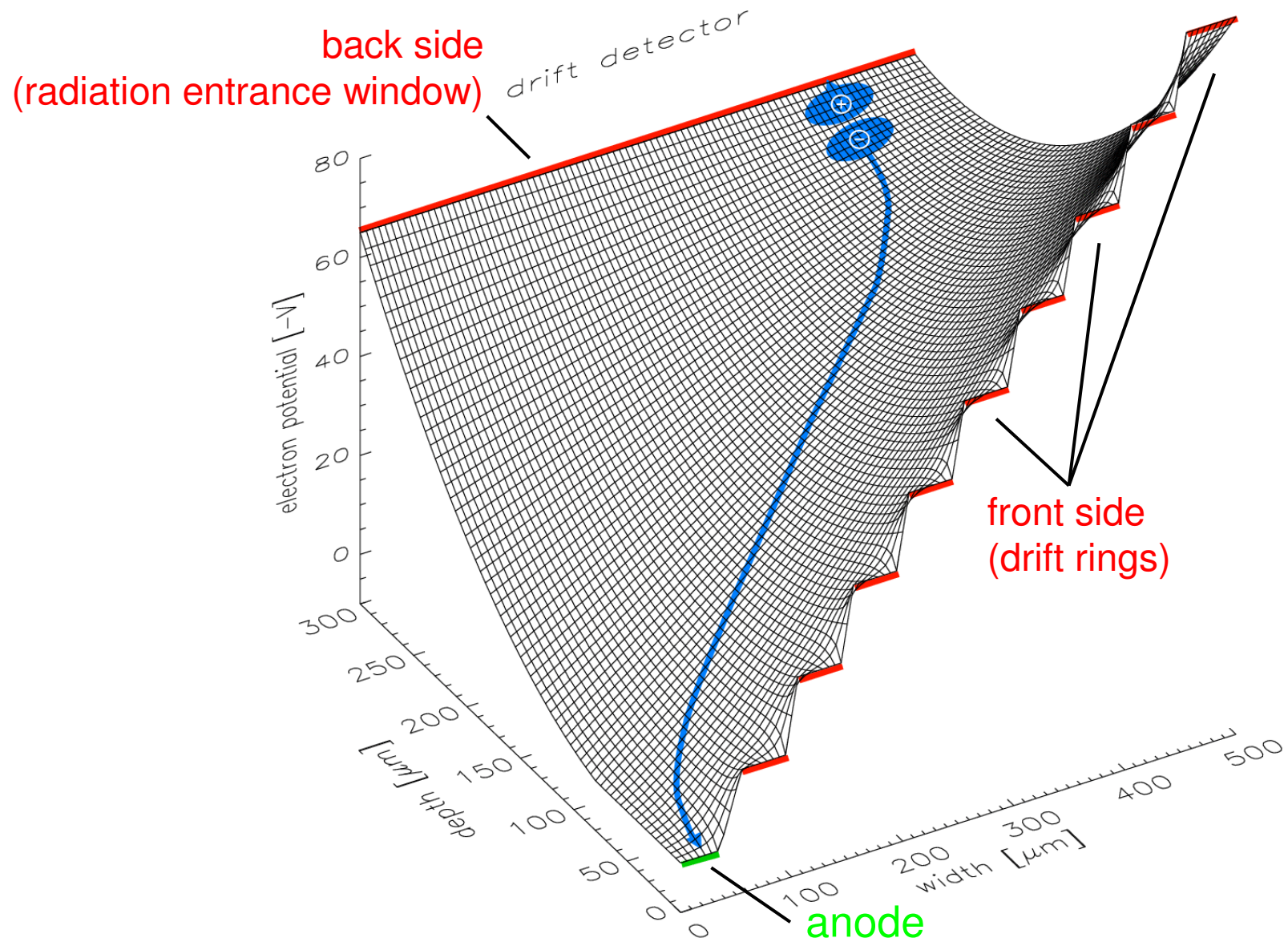



History

- 1970-76 Josef Kemmer develops planar technology for semiconductor detectors
- 1983 E. Gatti and P. Rehak introduce principle of silicon drift detector
- 1983 Cooperation between J. Kemmer, P. Rehak and MPI, first SDDs produced at TU München
- 1985-2001 Cooperation with MPI to develop new detector concepts: SDD with homogeneous entrance window, completely depleted pn-CCD for XMM X-ray telescope, DEPMOS, DEPFET
- 1991 Qualification of Kemmer's planar process for the MPI semiconductor laboratory completed
- 1998 First commercial SDD systems available
- 2003 2000th SDD system sold

Mounted Devices

- 5 mm², 10 mm²

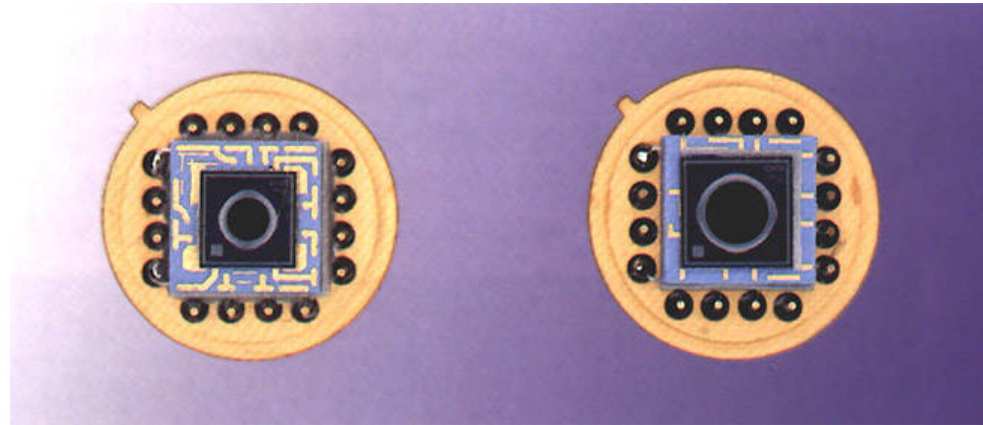

- 7 channel
detector with
35 mm²

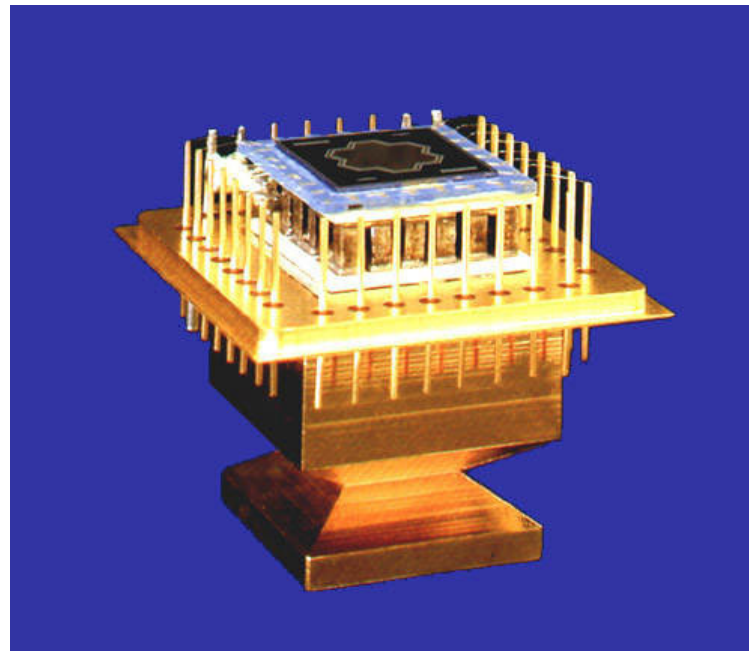

Mounted Devices

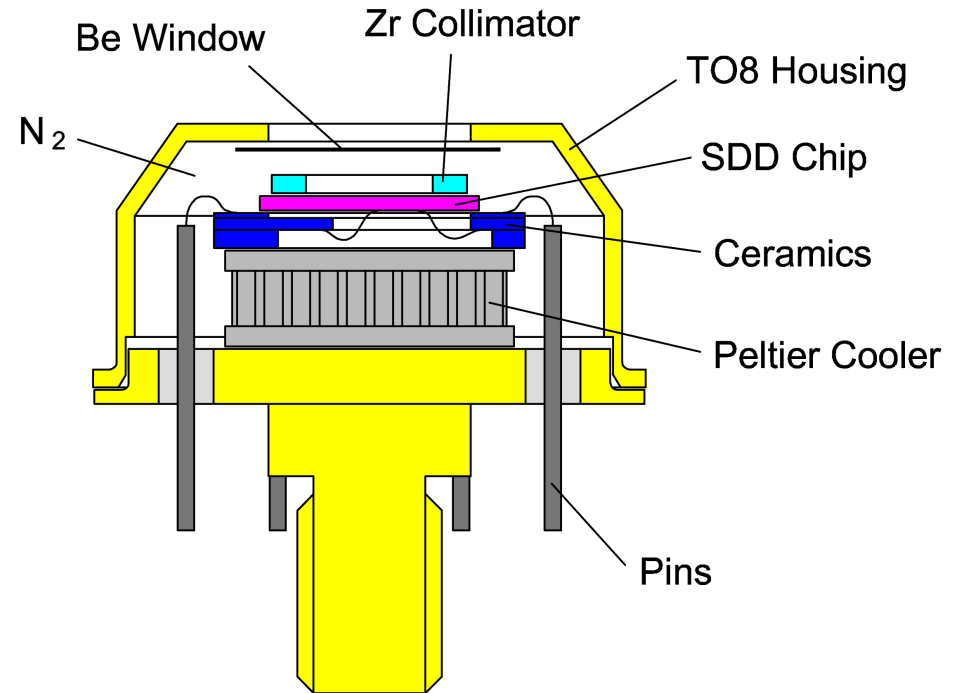
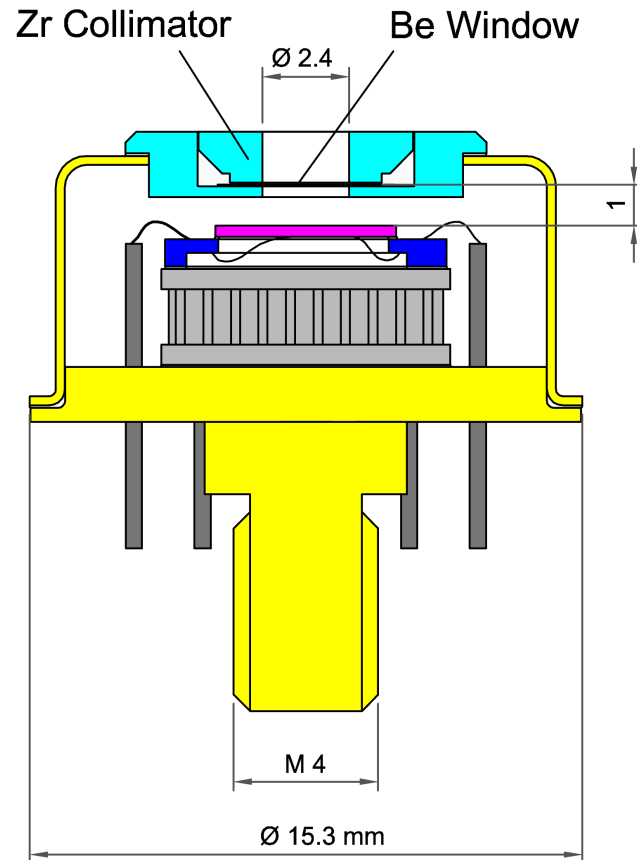

- Illuminated from back-side
- Anode continuously discharged \rightarrow no reset clock
- Standard: $8 \mu\text{m}$ Be window
- Polyimide window with Si grid also available
- N_2 filled housing (1 bar or 100 mbar)



243 eV

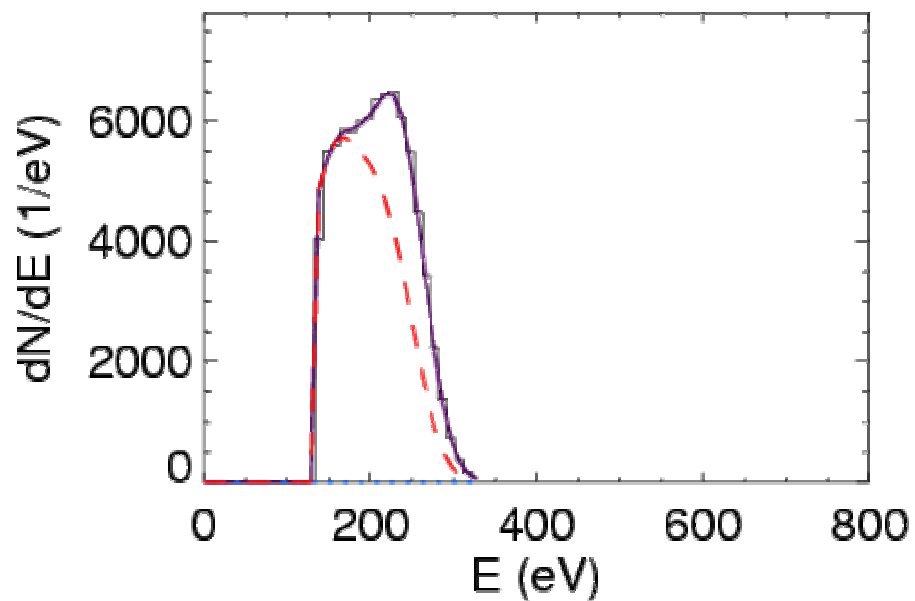

379 eV

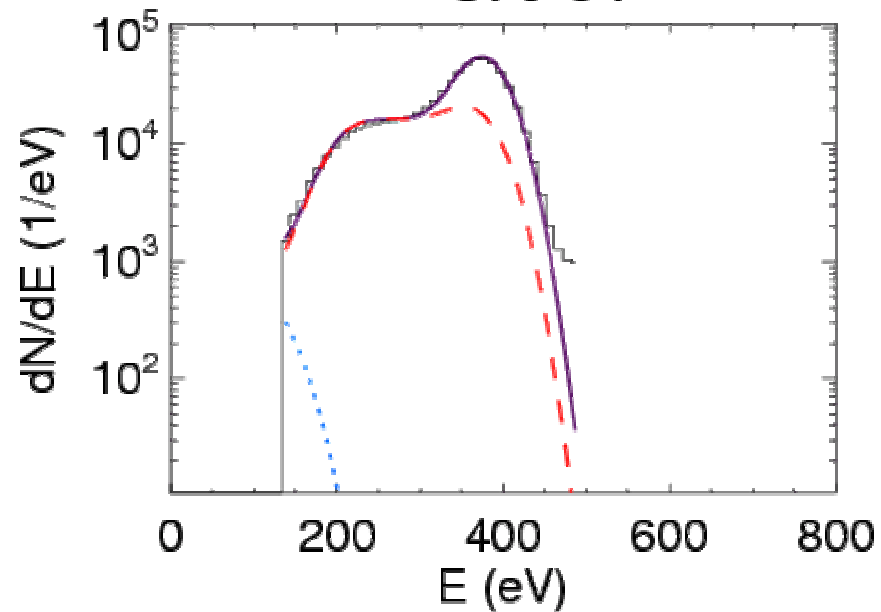

532 eV

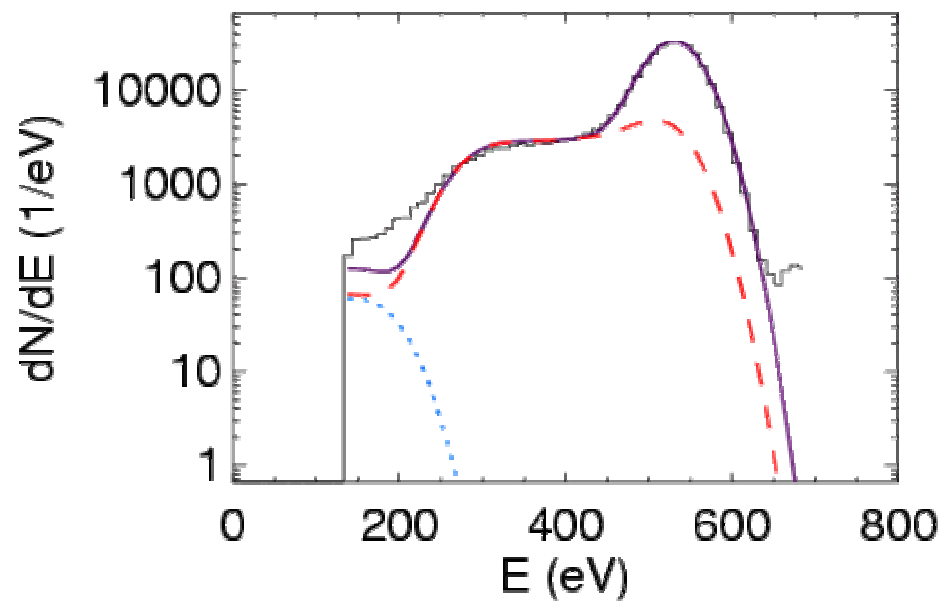

678 eV

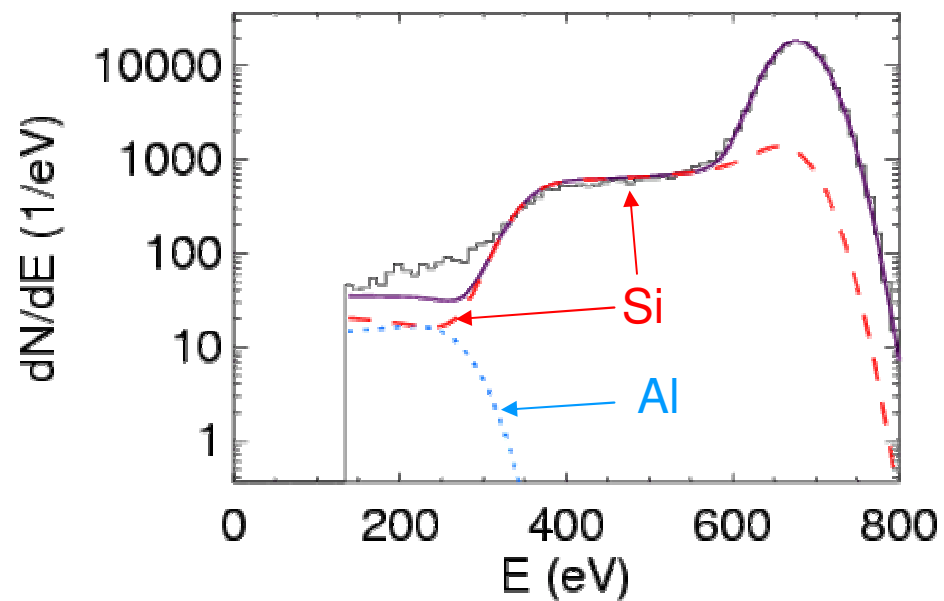

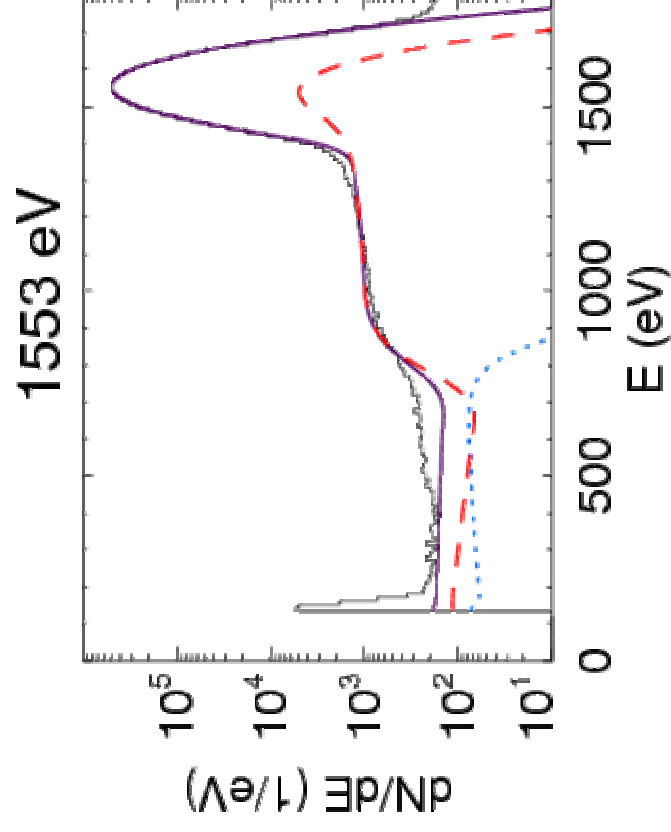
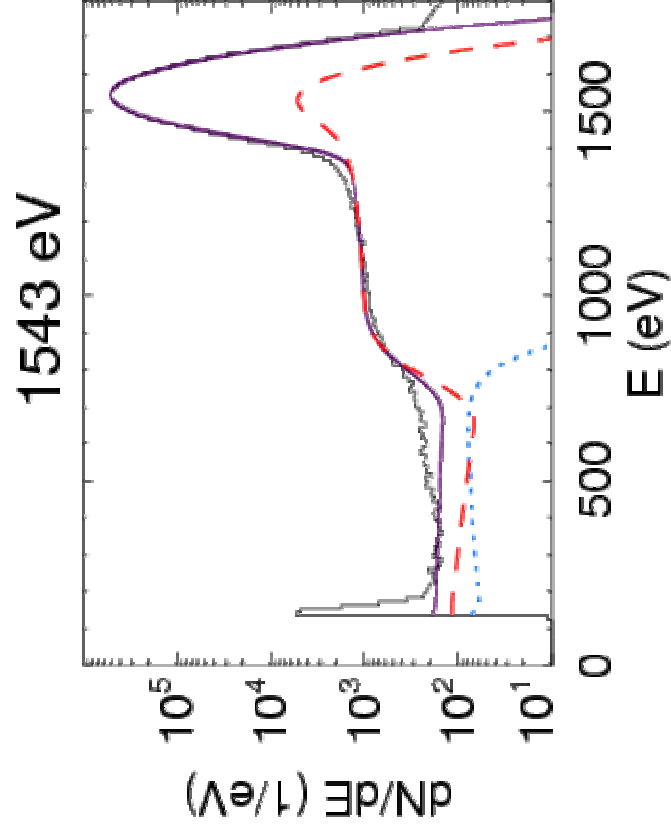
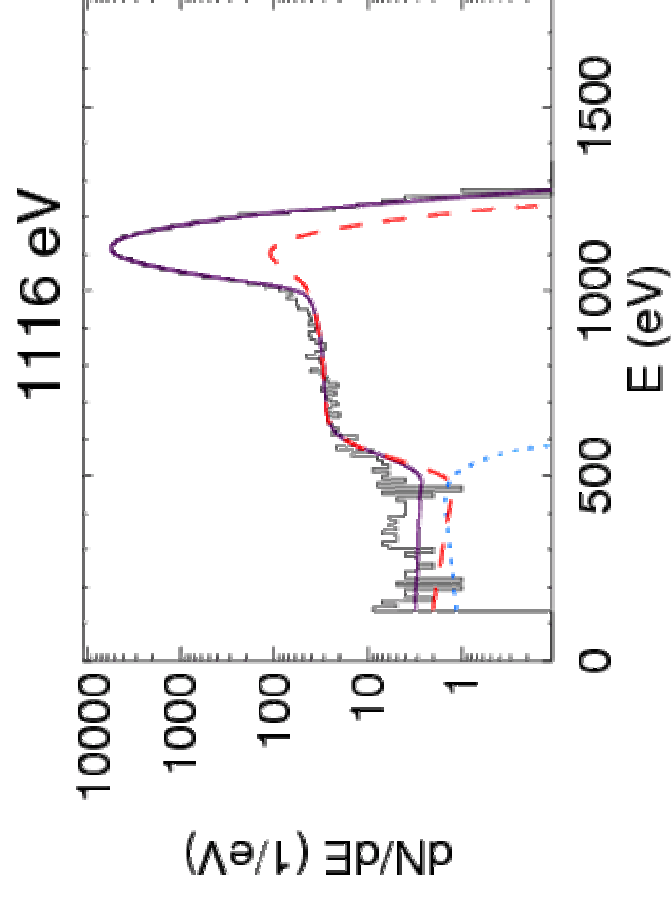
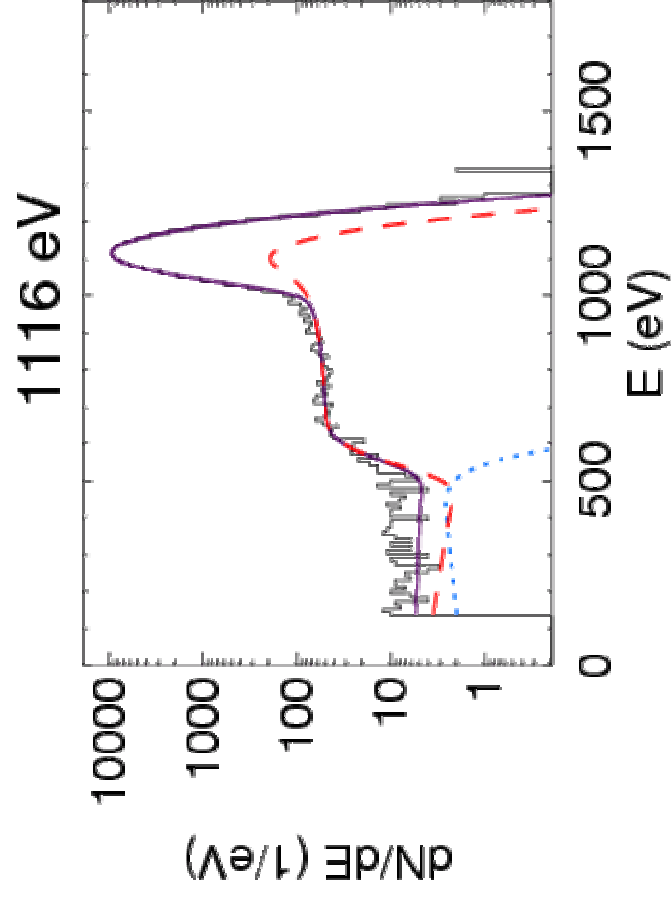

Semiconductor X-Ray Detectors

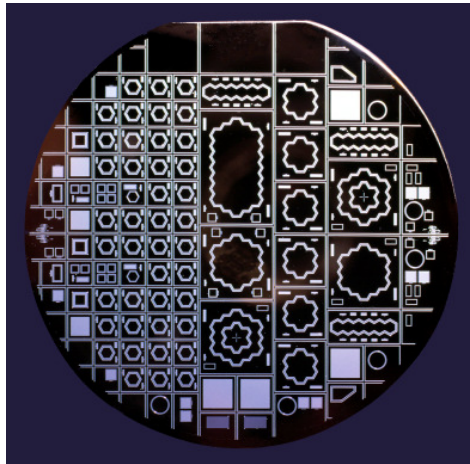

Part A Principles of Semiconductor Detectors

1. Basic Principles
2. Typical Applications
3. Planar Technology
4. Read-out Electronics

Part B Silicon Drift Detectors

1. Silicon Drift Detectors
2. GaAs Detectors
3. Outlook
4. Resume

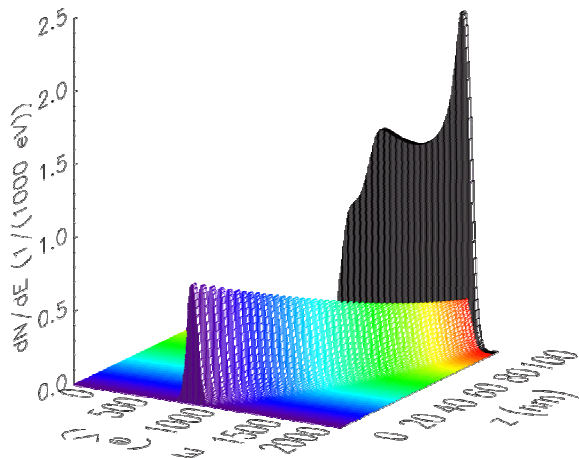

GaAs Detectors

- Silicon detectors with reasonable thicknesses (< 5 mm) are mainly sensitive to soft X-rays
- GaAs has higher Z and higher ρ \rightarrow high absorption probability
- XRF application: detection of X-rays > 30 keV elements have higher fluorescence yield
- Hard X-rays (\approx 100 keV) used in medicine: radiography, fluoroscopy, and nuclear medicine
- Detector with high efficiency \rightarrow reduces dose on patient
- Band gap of GaAs (1.42 eV) is high enough \rightarrow operation at room temperature operation possible
- Band gap is low enough for good resolution (Fano limit 140 eV FWHM at 5.9 keV, pair creation energy 4.2 eV)
- Large bulk resistivity \rightarrow high fields for charge collection
- Electron mobilities 6 x higher than Si \rightarrow Fast signal

Production of GaAs Detectors

- No natural oxide → Production not as easy as in Si planar technology
- Thickness $> 100 \mu\text{m}$ required for high efficiency detection of hard X-rays and γ -rays and low detector capacitance
- Not possible with molecular beam epitaxy
- Maximum thickness with chemical vapor phase deposition epitaxy: $60 - 100 \mu\text{m}$
- Most promising: liquid phase technology (Prof. Andreev, Ioffe Institute)
- Energy resolution of 220 eV obtained with 0.04 mm^2 pixels @ 5.9 keV and -30°C
- Drift principle required to reduce capacitance
- Very important: high purity epitaxial layer

Semiconductor X-Ray Detectors

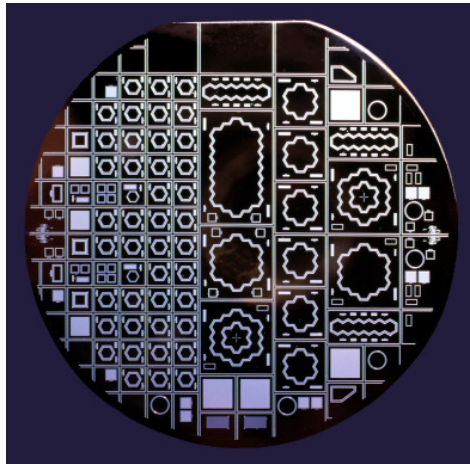

Part A Principles of Semiconductor Detectors

1. Basic Principles
2. Typical Applications
3. Planar Technology
4. Read-out Electronics

Part B Silicon Drift Detectors

1. Silicon Drift Detectors
2. GaAs Detectors
3. Outlook
4. Resume

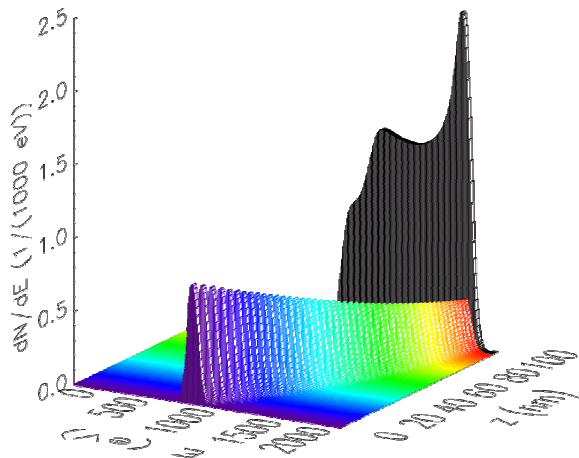

Outlook

- Focus in the past: Silicon drift detectors and read-out electronics → spectrometer
- Competitors: High-end: Si(Li)s, HPGe (for γ)
Low-end: pin-Diodes
- Future Targets:
 - SDDs with larger areas ($> 10 \text{ mm}^2$)
 - Less charge loss at $E_0 < 300 \text{ eV}$
 - Scintillator-covered SDDs for γ -rays
 - GaAs detectors for hard X-rays ($E_0 > 50 \text{ keV}$)

The Response of Energy Dispersive X-Ray Detectors

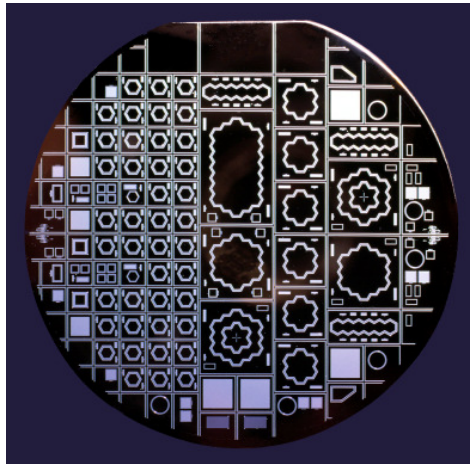

Part A Principles of Semiconductor Detectors

1. Basic Principles
2. Typical Applications
3. Planar Technology
4. Read-out Electronics

Part B Silicon Drift Detectors

1. Silicon Drift Detectors
2. Low Energy Measurements/Experimental Setup
3. Calculation of Spectral Contributions
4. Results
5. Resume

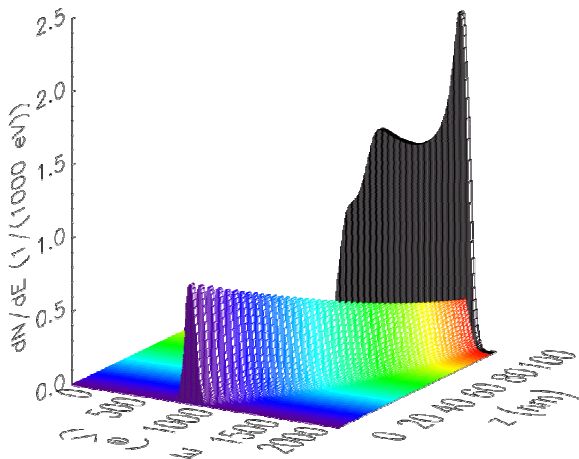

Resume

- Ketek's Silicon Drift Detector is a unique and established product for XRF and SEM applications
- Highly optimized production process → low leakage currents
- Drift principle → low capacitance
- → Low overall noise
- → very good energy resolution
- → high count-rate ability
- Future tasks:
 - Expand energy range to both, higher and lower X-ray energies
 - High E : GaAs detectors
 - Low E : SDD with optimized entrance window
- www.ketek.biz / www.ketek.net
- Спасибо!

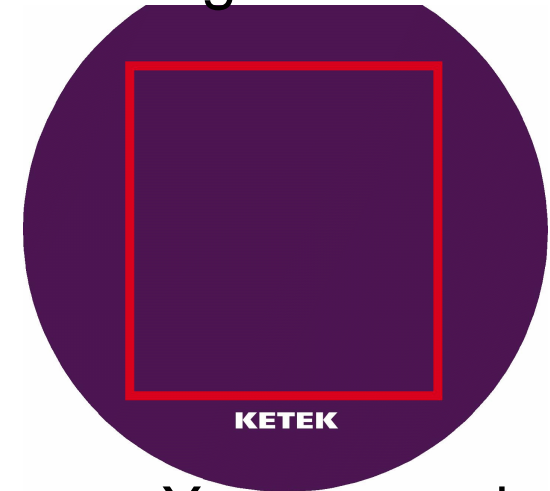

KETEK

X-ray photon hits detector

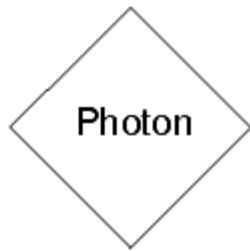

Interaction always by
photoelectric effect

Compton effect unlikely

e^-e^+ pair creation impossible

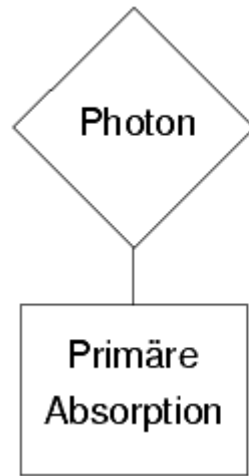

Creation of one photo electron

$$E = E_0 - E_B$$

$E_0 >$ Si K shell: K electron

$E_0 <$ Si K shell: L electron

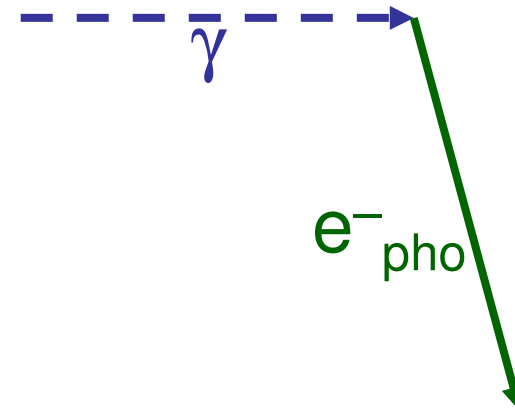
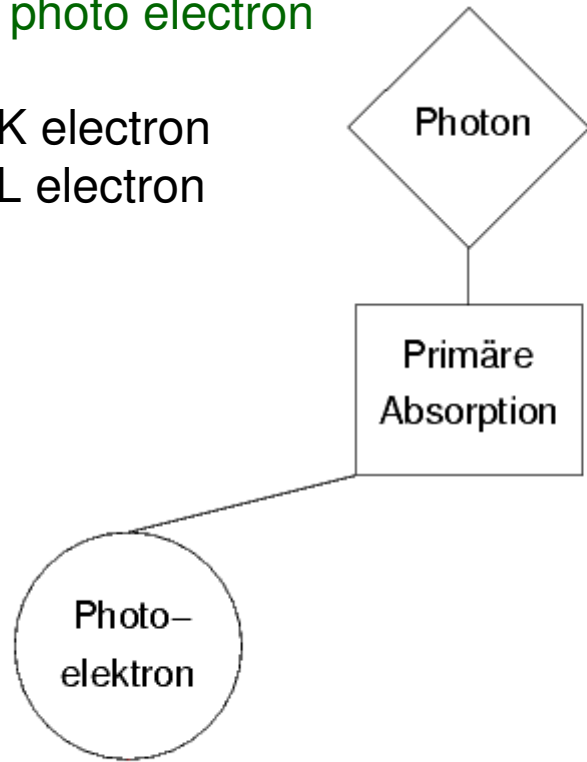

K or L electron knocked off its shell

➤ atom single ionized

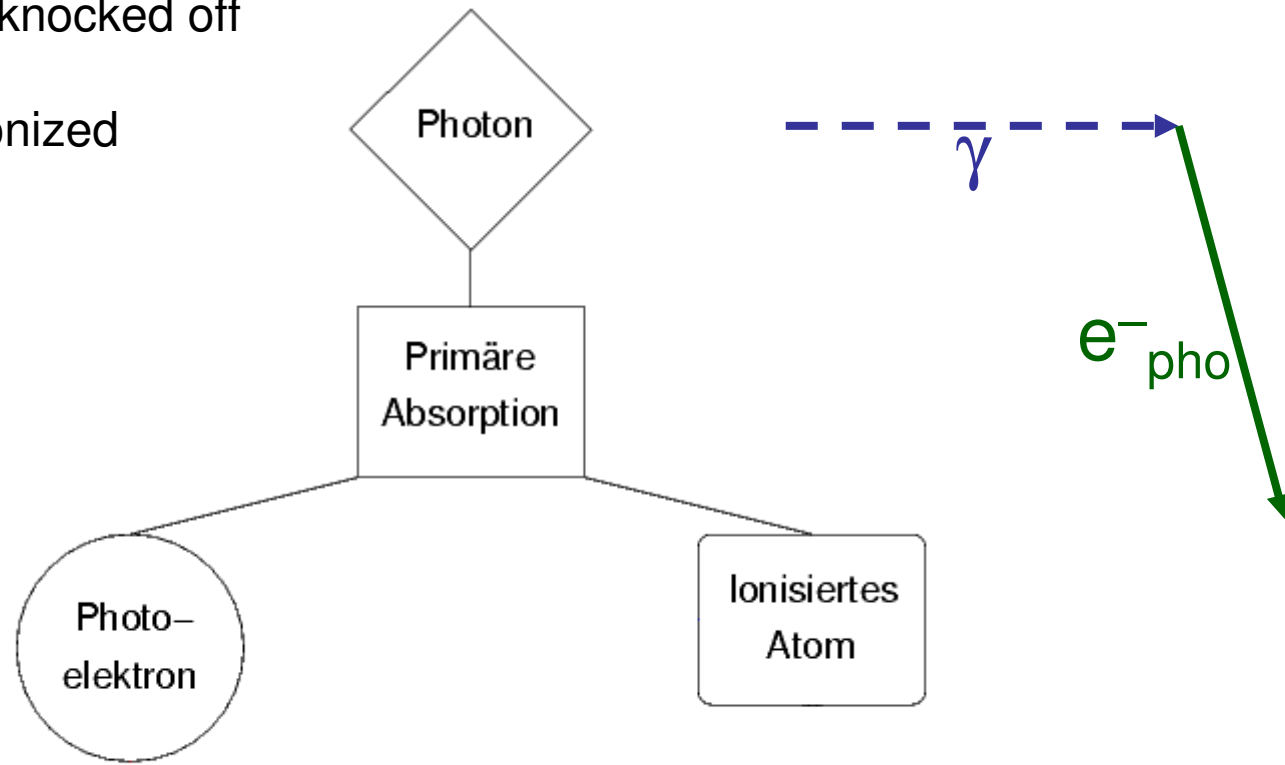

Hole in K or L shell filled with electrons from higher shells. Energy difference assigned to fluorescence photon or **Auger electron** of fixed energy

Fluorescence yields:
L shell: 0%
K shell: 4%

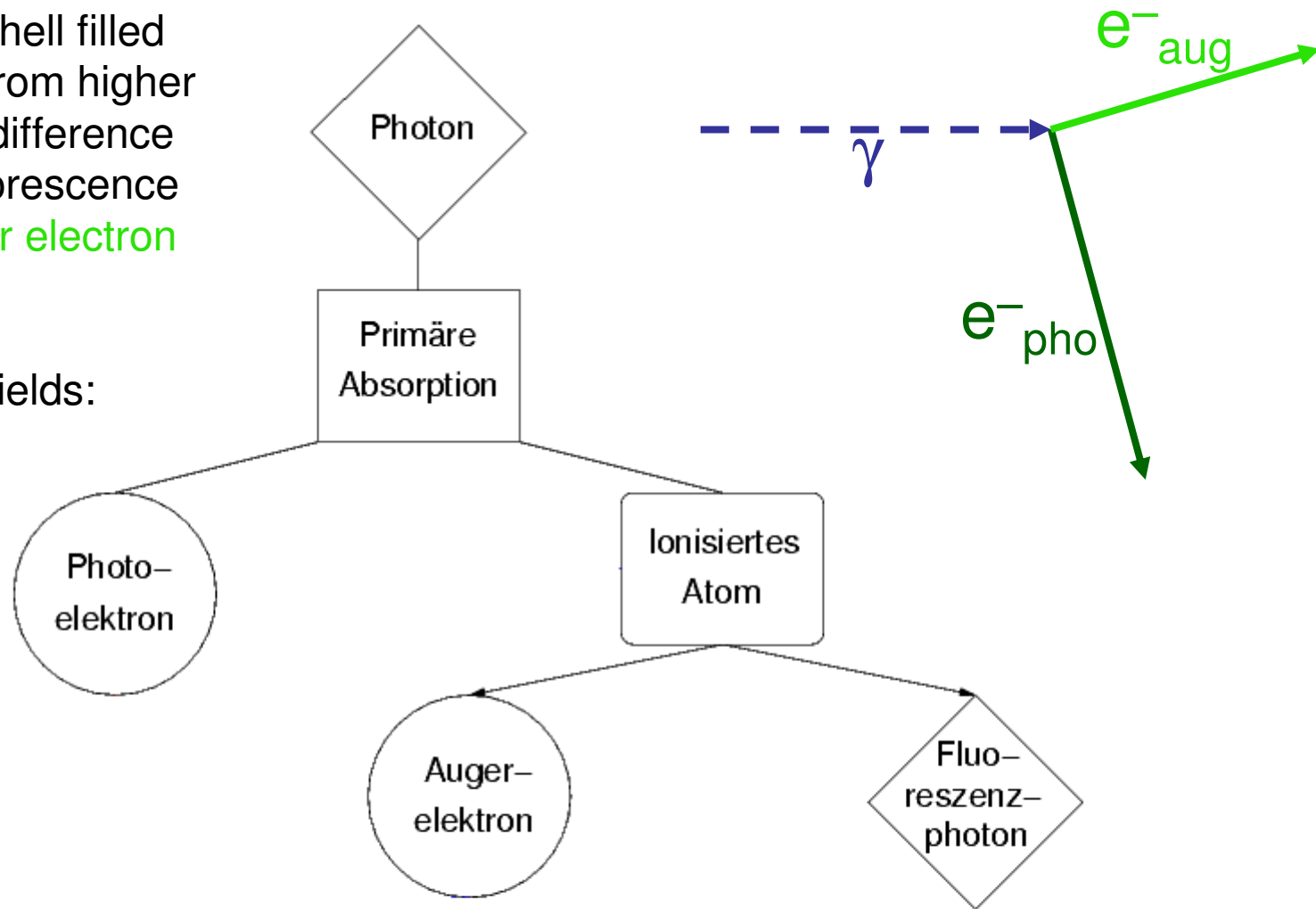

Primary photo electron
scatters and can generate
secondary electrons from
Si atoms

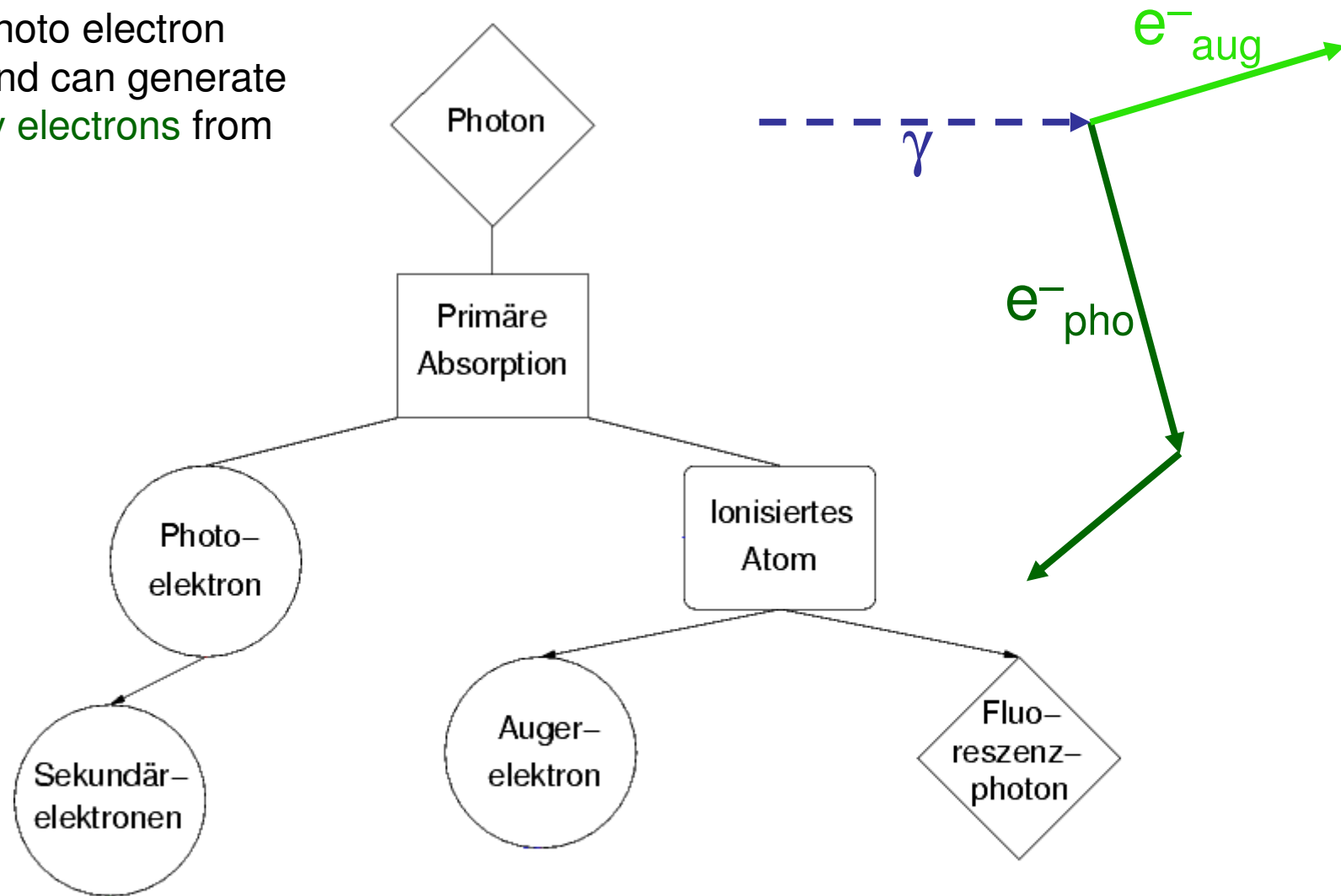

More atoms are ionized
and further **Auger electrons**
emerge

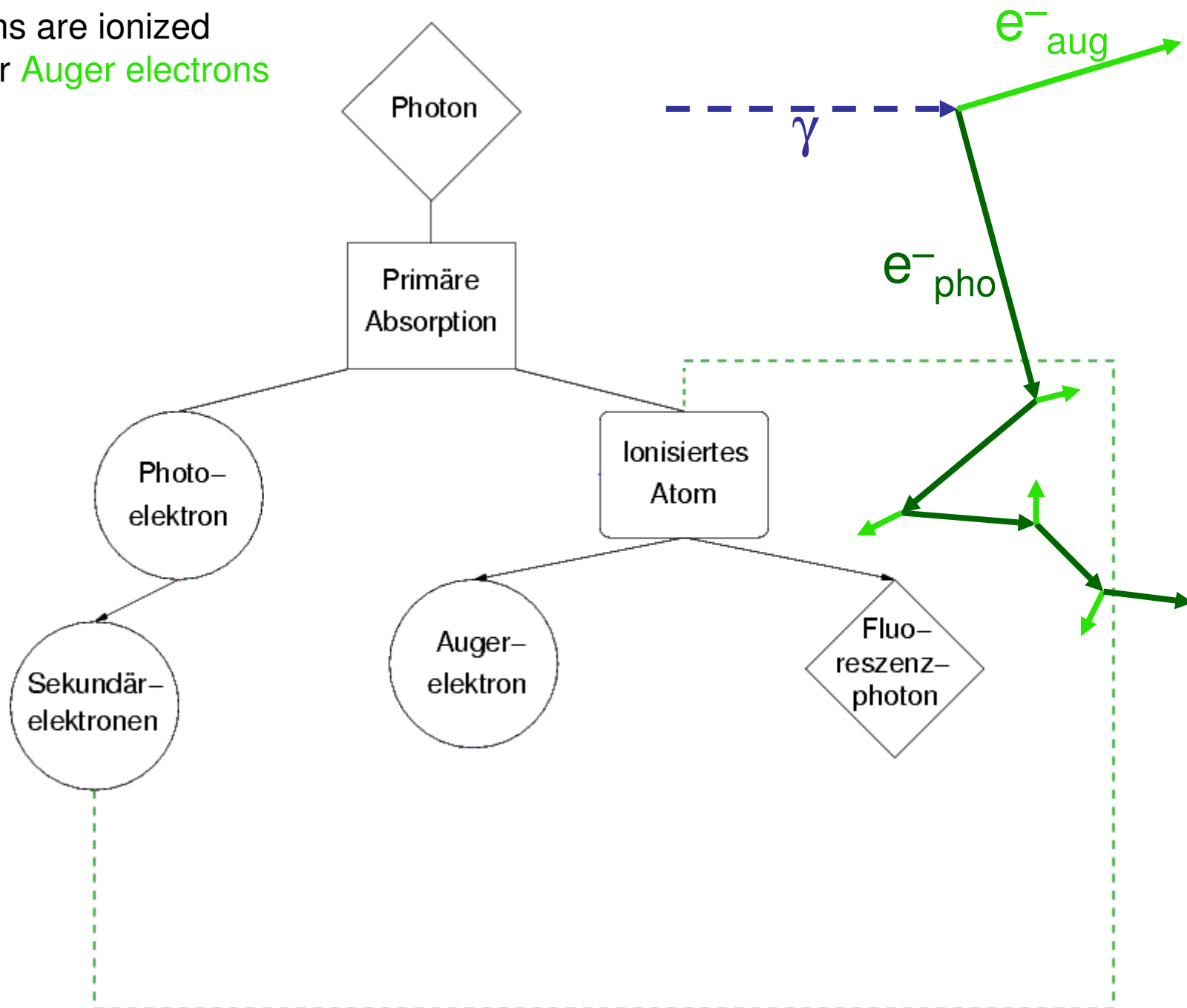

Also possible:
Scattering at lattice, i.e.
energy carried to phonons
Very probable at low energies

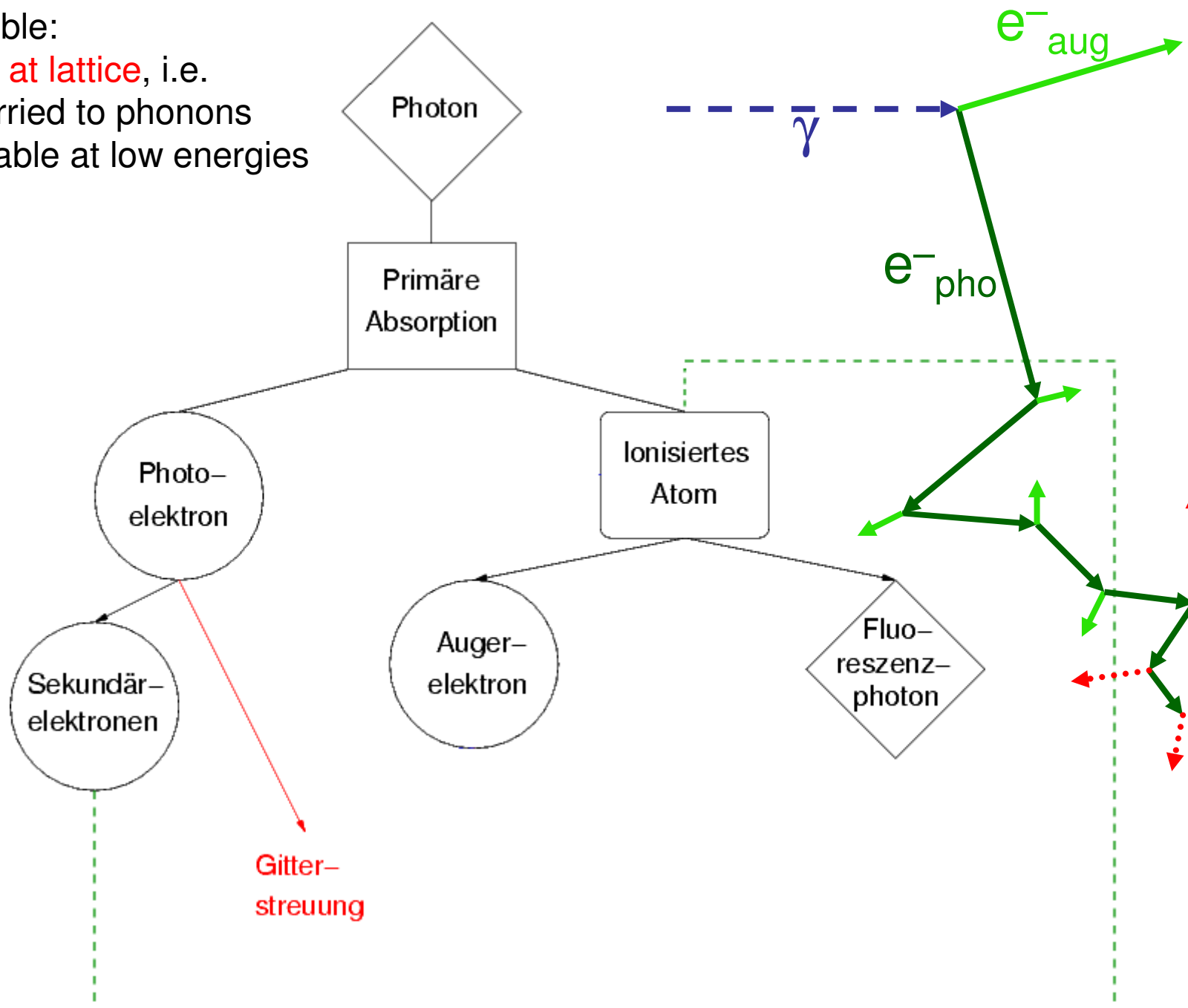

The primary Auger electron also produces secondaries and **phonons**

Number of electrons generated:
Ionization/Fano statistics

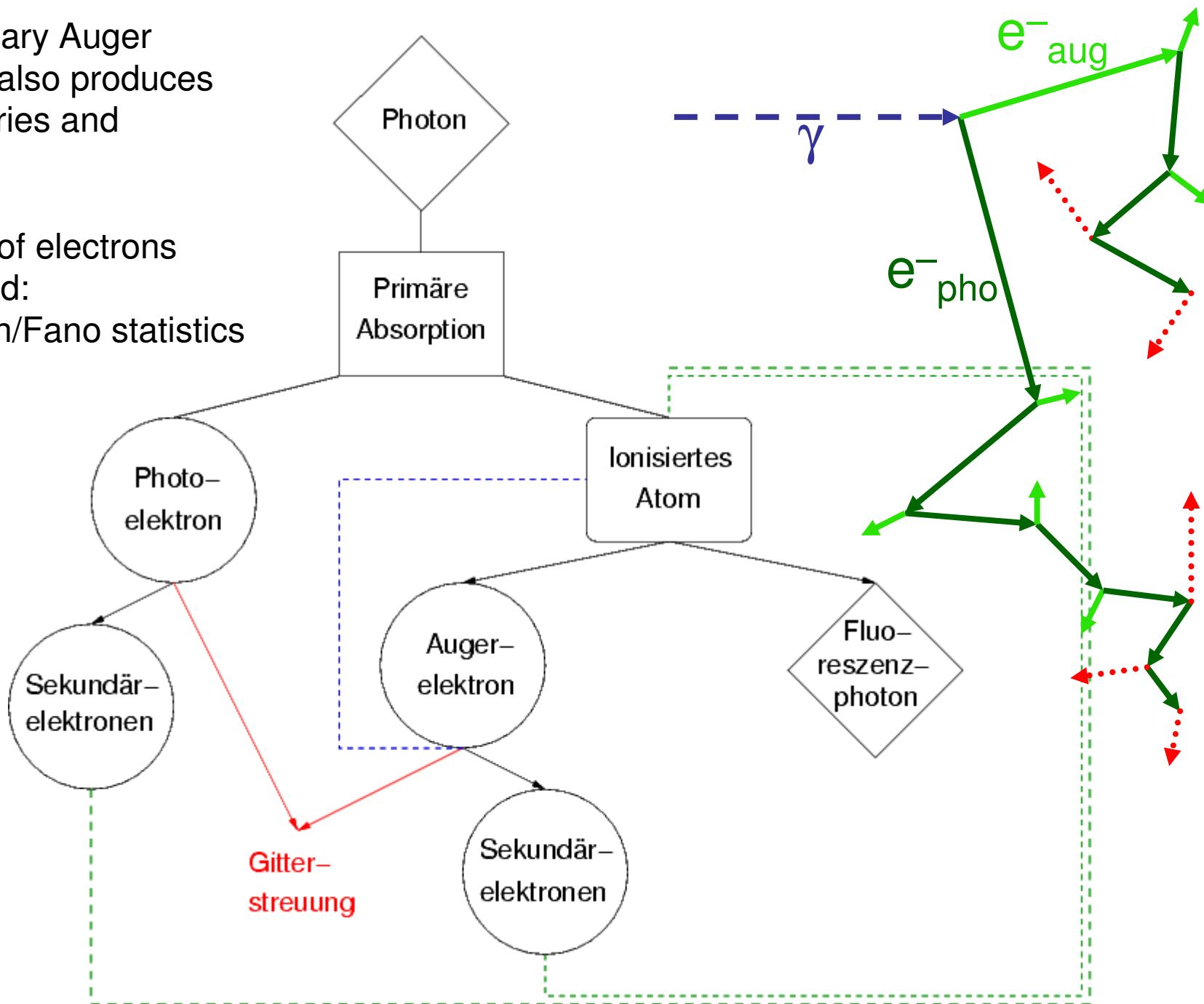

K shell fluorescence:
X-ray can escape or is
reabsorbed inside detector

